

Central Survey Group CAD Standard

*Last Updated: 01/03/2022
Reviewed/Released 2022 v1.0*

TABLE OF CONTENTS

- 1.0 CENTRAL SURVEY GROUP CAD STANDARD 1**
 - 1.1 FOREWORD 1**
 - 1.2 PURPOSE 1**
 - 1.2.1 ABOUT THIS STANDARD 1
 - 1.3 ACCESSING THE CSG CAD STANDARD..... 1**
 - 1.3.1 USING THE STANDARD FILES 2
 - 1.3.2 DISTRIBUTION FILES 3
 - 1.4 PROJECT DIRECTORY STRUCTURE AND FILE NAME CONVENTION 4**
 - 1.4.1 PROJECT DIRECTORY STRUCTURE..... 4
 - 1.4.2 FILE NAMING CONVENTION 5
 - 1.5 CAD PRACTICES AND PROCEDURES 6**
 - 1.5.1 LAYERING SCHEME DEFINITION..... 6
 - 1.5.2 MULTI-LEVEL INFORMATION 7
 - 1.5.3 ENTITY AND LAYER LINETYPES..... 7
 - 1.5.4 ENTITY AND LAYER COLORS 7
 - 1.5.5 SYMBOLOGY 7
 - 1.5.6 PLOTTED LINEWEIGHTS 8
 - 1.5.7 TEXT STYLE AND HEIGHTS..... 10
 - 1.5.8 DRAWING UNITS AND PRECISION..... 11
 - 1.5.9 COORDINATE SYSTEM 11
 - 1.5.10 COORDINATE GRIDS..... 11
 - 1.5.11 DRAWING ACCURACY 11
 - 1.6 SHEET CREATION 11**
 - 1.6.1 USING THE REVISION BLOCK WITHIN THE CONTRACT BORDER..... 12
 - 1.7 DATA COLLECTION PRACTICES AND PROCEDURES 12**
 - 1.7.1 DESCRIPTION KEYS..... 12
 - 1.8 AERIAL MAPPING REQUIREMENTS 12**
 - 1.8.1 COORDINATE SYSTEM 12
 - 1.8.2 SECTOR GRID 12
 - 1.8.3 AERIAL PHOTOGRAPHS..... 12
 - 1.8.4 FILE NAMES 12
 - 1.9 DIGITAL SUBMITTAL REQUIREMENTS 13**
 - 1.9.1 CAD FILE FORMAT..... 13

1.9.2	CIVIL 3D UTILITY SUBMITTALS.....	13
1.9.3	SUBMITTAL REQUIREMENTS	13
1.9.4	HARDCOPY SUBMITTALS	14
1.9.5	DIGITAL MEDIA SUBMITTALS	14
1.9.6	PROJECT WEBSITE (LIVELINK) SUBMITTALS.....	14
1.10	CONCLUSION.....	14
1.11	APPENDIX A – LAYER STRATEGEM.....	14
1.11.1	ALIGNMENTS.....	14
1.11.2	BUILDINGS	15
1.11.3	CONTROL.....	15
1.11.4	ENVIRONMENTAL.....	15
1.11.5	GENERAL.....	16
1.11.6	HYSOGRAPHY	16
1.11.7	LEGAL.....	17
1.11.8	MARKINGS	17
1.11.9	PAVEMENT.....	17
1.11.10	PROFILES	18
1.11.11	RAILROAD.....	18
1.11.12	SECTIONS	18
1.11.13	SIGN.....	19
1.11.14	SITE WORK.....	19
1.11.15	UTILITIES	20
1.11.16	POINTS	22
1.12	APPENDIX B - FIELD DESCRIPTION CODE.....	23
1.13	APPENDIX C - LINETYPES.....	39
1.14	APPENDIX D – SYMBOLS BY FEATURE SET	48
1.14.1	FEATURE SET: OUT OF SERVICE	48
1.14.2	FEATURE SET: BUILDING	48
1.14.3	FEATURE SET: CONTROL.....	49
1.14.4	FEATURE SET: ENVIRONMENTAL	49
1.14.5	FEATURE SET: GENERAL	50
1.14.6	FEATURE SET: HYSOGRAPHY.....	51
1.14.7	FEATURE SET: PAVEMENT MARKINGS	51
1.14.8	FEATURE SET: PAVEMENT, ROAD, AND PARKING	52

1.14.9	FEATURE SET: RAILROAD	53
1.14.10	FEATURE SET: SIGN	54
1.14.11	FEATURE SET: SITE FEATURES	55
1.14.12	FEATURE SET: UTILITIES.....	58
1.15	APPENDIX E – LEGENDS- LINETYPES.....	81
1.16	APPENDIX F – CONTRACT BORDERS	82
	CONTRACT BORDER.....	82
1.16.1	82	
1.16.2	CONTRACT BORDER – OS	83
1.16.3	CONTRACT BORDER - AM.....	85
1.17	APPENDIX G - CIVIL 3D.....	86
1.17.1	DATA SHORTCUTS (CIVIL 3D OBJECT SHARING)	86
1.17.2	SHARING DATA SHORTCUTS	86
1.17.3	PIPE NETWORKS	88
1.18	APPENDIX H - REQUEST TO CHANGE STANDARD	91

CHANGES TO THE STANDARDS

2020	File / Section	Description
	Section 1.4 Accessing the CSG CAD Standard	Updated CSG Standards folder path and Figure 1-A.
	Section 1.6.7 Text Style and Heights	Updated Font column.
	Section 1.15 Appendix E	Updated PANYNJ logo in Linetype Legend.
	Section 1.16.1 Contract Border	Updated PANYNJ logo in Contract Border.
	Section 1.16.2 Contract Border - OS	Updated PANYNJ logo in Contract Border - OS.
	Section 1.16.3 Contract Border - AM	Updated PANYNJ logo in Contract Border - AM.
2021	File / Section	Description
First Quarter	Change Tracker	Moved after the table of Content
	Section 1.3 Digital Submittal Requirements	Moved to the end and now is section 1.9
	Section 1.9 File Name Convention	Now section 1.4.2. Merged with Section 1.4 Project Directory Structure
	Table 1-A	Table Format Updated
	Section 1.10 Conclusion	New Section Added

1.0 CENTRAL SURVEY GROUP CAD STANDARD

1.1 FOREWORD

The Central Survey Group Computer Aided Drafting Standard outlined within this document was established to provide guidance for the preparation and maintenance of facility CAD drawings.

This document is intended for use by both in-house personnel as well as outside consultants involved in creating or updating PANYNJ facilities' Computer Aided Drafting (CAD) data.

1.2 PURPOSE

This Standard establishes requirements and procedures for the preparation and submission of CAD based drawings throughout the project life cycle. Adherence to this standard ensures that the Central Survey Group of the PANYNJ will receive and produce data in a consistent format. This consistency will improve the compatibility of this data with the E/A Design Division and will allow the PANYNJ to maximize its investment in mapping by capturing and effectively using extended information.

The role of an individual assigned to the project determines the level of understanding required of the CSG CAD Standard. For CAD operators, surveyors, and functional supervisors a thorough knowledge of all CAD related elements associated with a project is crucial. The project manager however only requires a general knowledge of the CSG CAD Standard and the means by which it is employed to create a project. Both levels of knowledge will be possible using this manual.

The CAD system adopted by the PANYNJ is comprised of several Autodesk products. Throughout this manual, terminology and references will be made that are unique to Autodesk and primarily different AutoCAD based software applications.

1.2.1 ABOUT THIS STANDARD

The chapters within this standard describe how the Central Survey Group uses AutoCAD and how to configure AutoCAD to support the CSG CAD Standard, which it has adopted.

1.3 ACCESSING THE CSG CAD STANDARD

The CSG CAD Standard includes a series of support files. All support files are provided internally on sharepoint located at [Eng Operations Project Controls - VDC Group - VDC Documents - All Documents \(sharepoint.com\)](#) on the PANYNJ network.

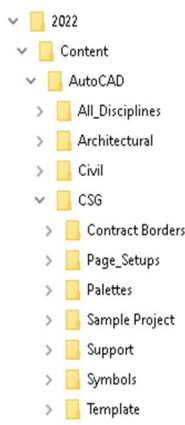

The “CSG” folder contains seven subfolders as illustrated in Figure 1. These subfolders contain the Central Survey Group specific support files including drawing templates, layer drawings, tool palettes, page setups and symbols. Graphic depictions of the symbols used can be referenced in **1.14 Appendix D – Symbols by Feature Set**.

Upon entering a project into the survey log, the following project directory structure will be generated as depicted in Figure 1-A. No files are permitted within the root of the Projects, YYYY, SRN_FAC_Description and Project Data Folders. Folders are not to be renamed, as they are standard, however additional folders can be created under the PROJECT DATA sub folder as necessary.

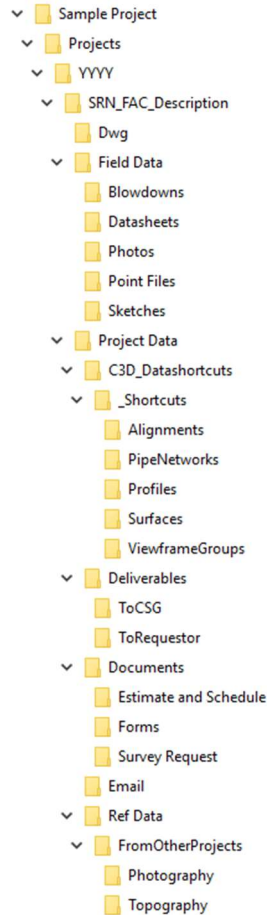

Figure 1-A

1.3.1 USING THE STANDARD FILES

The CSG_Standards directory contains two primary types of files: files that do not require ongoing user interaction and those that do.

The first type refers to support files accessed automatically by AutoCAD once they have been copied to the proper support folders. All CSG workstations have already been configured to access these files. Outside consultants should copy these files to the appropriate directories or create an AutoCAD profile pointing to the files as necessary.

The second type refers to files such as title sheets, contract borders and stamps, which the user must configure within the project. For instructions on creating a title sheet or working with the contract borders, refer to **1.6 Sheet Creation** in this standard.

1.3.2 DISTRIBUTION FILES

This section identifies the files supplied for general use within the CSG CAD Standard. The entire Central Survey Group CAD Standard can be found internally at [Eng Operations Project Controls - VDC Group - VDC Documents - All Documents \(sharepoint.com\)](#) or externally downloaded from: <https://www.panynj.gov/port-authority/en/business-opportunities/engineering-available-documents.html>

VDC Documents>02. Development>2022>Content>AutoCAD>CSG	
	Contains the "CSG_CAD_Standard" and "Request to Change Standard" documents.
Contract Borders	Contains Title Sheet and Contract Borders and Stamps.
Page Setups	Contains pre-configured page setups for plotting drawings to CSG devices
Palettes	Contains Tool Palettes for use by the Central Survey Group
Sample Project	Contains a Sample Folder structure that mimics the Folder Structure used when new projects are created.
Support	Contains necessary support files for custom CSG CAD Standard content
Symbols	Contains all the symbol library files (.dwg) used by CSG
Template	Contains all drawing and layer template files used by CSG
VDC Documents>02. Development>2022>Content>AutoCAD>CSG>Contract Borders	
Confidential Note.dwg	Confidential note drawing to be placed on confidential drawings.
Confidential Note.jpg	Confidential note image to be placed on confidential documents.
Contract_Border – AM.dwg	30x42 border for aerial survey drawings.
Contract_Border – OS.dwg	34x56 border for oversize survey drawings.
Contract_Border.dwg	34x56 border for standard survey drawings.
Drawing_Info – OS..dwg	Drawing Information Stamp for 34x56 drawings
Drawing_Info – Stamp_NJ&NY LS - OS..dwg	Consultant company providing NJ & NY PLS signatures on 34x56 drawing
Drawing_Info – Stamp_NJ&NY LS.dwg	Consultant company providing NJ & NY PLS signatures on 22x34 drawing
Drawing_Info – Stamp_NJPLS.dwg	Consultant company providing NJ PLS signatures on 22x34 drawing
Drawing_Info – Stamp_NYLLS - OS.dwg	Consultant company providing NY LLS signatures on 34x56 drawings
Drawing_Info – Stamp_NYLLS.dwg	Consultant company providing NY LLS signatures on 22x34 drawings
Drawing_Info – Stamp_PAPD.dwg	Drawing Information Stamp for PAPD drawings.
Drawing_Info – Stamp_Revision.dwg	Revision Stamp for use on all CSG borders
Drawing_Info – Stamp_Triangle.dwg	Revision triangle marker for placement near revision clouds
Drawing_Info.dwg	Drawing Information Stamp for 22x34 drawings
PAPD-Official.jpg	PAPD Image for use with PAPD Drawings
VDC Documents>02. Development>2022>Content>AutoCAD>CSG>Page_Setups	
CSG.dwg	Drawing file containing pre-configured page setups for plotting drawings.
VDC Documents>02. Development>2022>Content>AutoCAD>CSG>Palettes	
PA-CentralSurvey	Generic Tool Palettes for use by the Central Survey Group.
VDC Documents>02. Development>2022>Content>AutoCAD>CSG>Sample Project	
	Contains a Sample Folder Structure that mimics the Folder Structure used when new projects are created.
VDC Documents>02. Development>2022>Content>AutoCAD>CSG>Support	
PA.shx	Compiled shape file containing custom shapes used throughout the CSG profile.
PA - CSG - LONG.lin	Line type definition file containing custom line types long segments.

PA - CSG - SHORT.lin	Line type definition file containing custom line types for short segments.
PA - CSG.lin	Line type definition file containing custom line types.
VDC Documents>02. Development>2022>Content>AutoCAD>CSG>Symbols	
	For listing of CSG Symbols refer to section 1.14 titled Appendix D – Symbols by Feature Set
VDC Documents>02. Development>2022>Content>AutoCAD>CSG>Template	
PA - CSG-C3D.dwg	Civil 3D 2018 CSG Template drawing containing all styles.
PA - deci-feet.dwt	Civil 3D 2018 CSG Template drawing containing no styles. To be used to import necessary styles when starting a new drawing.

1.4 PROJECT DIRECTORY STRUCTURE AND FILE NAME CONVENTION

The CSG CAD Standard provides a structure for the organization of CAD projects within the department.

The primary goal of this structure is to improve coordination within CSG and its consultants, as well as to develop CAD projects in a way that will facilitate the further use of the electronic information beyond the initial contract.

1.4.1 PROJECT DIRECTORY STRUCTURE

All CSG CAD projects are stored on the CAD volume of a central server, which has internally been mapped using the drive letter “M:\” Facility folders when used are named using its facility code as displayed in **Table 1-A**.

Table 1-A

Facility Code	Facility Name
AMT	Automobile Marine Terminal
BB	Bayonne Bridge
BRKMT	Brooklyn Port Authority Marine Terminal
EP	Elizabeth Port Authority Marine Terminal
EWR	Newark Liberty International Airport
FERRY	Ferry Transportation
GB	Goethals Bridge
GWB	George Washington Bridge and Bus Terminal
HCMF	Harrison Car Maintenance Facility
HELI	Downtown Manhattan Heliport
HH	Howland Hook Marine Terminal
HT	Holland Tunnel
IPY	Industrial Park at Yonkers
JFK	John F. Kennedy International Airport
JSTC	Journal Square Transportation Center
LGA	LaGuardia Airport
LT	Lincoln Tunnel

MULTI	Multi Facility Projects
NFC	Newport Financial Center
NJMT	New Jersey Marine Terminals
NLCC	Newark Legal and Communication Center
OBX	Outerbridge Crossing
PABT	Port Authority Bus Terminal
PACD	Port Authority Police Academy
PATC	Port Authority Technical Center
PATH	Port Authority Trans-Hudson Corporation
PHQ	Police Headquarters
PJ	Port Jersey
PN	Port Newark
PRTC	Police Rescue Training Center
RLLC	Cross Harbor Rail Road NY/NJ
SWF	Stewart International Airport
TEB	Teterboro Airport
TLPT	Staten Island Teleport
WTC	World Trade Center

1.4.2 FILE NAMING CONVENTION

When submitting electronic documents to the Port Authority CSG the Service Request Number (SRN) shall be used as a unique identifier assigned by CSG projects for all. Each drawing shall be named in accordance following the name standard requirement.

1.4.2.1 GEOMETRY DRAWINGS

A Geometry drawing is the actual mapping drawing and contains plot sheets defined in paperspace / layout space. The file names will take form of:

Acronym	Description
SRN	Service Request Number
FC	Facility Code (reference Table 1-A)
YYYYMMDD	Field Work Start Date
NXXXX	Coordinate System Code
User Description	A description of up to 24 characters, including spaces. The following characters are not permitted < > / \ " ' ; : ? * , = ' & %

[CSG HOLD NUM]_[FACILITY CODE]_[FIELD WORK START DATE]_[COORDINATE SYSTEM CODE]_[DESCRIPTION]

Example of a drawing for mapping at Port Newark on January 15, 2018 with a CSG Survey Request Number of 2018-125 would be named:

- 2018-125_PN_20180115_NJ83F_GroundFeatures.dwg

1.5 CAD PRACTICES AND PROCEDURES

CAD drawing files must be consistently formatted in order to provide an effective method of data dissemination and retrieval. To that end, this Standard will guide the user in the requirements of CAD file naming, layer naming, graphic symbology, lettering styles, drawing units and other features.

1.5.1 LAYERING SCHEME DEFINITION

All layers contained within the Central Survey Group drawings have been defined using variations of the Tri-Services and the AIA layer guidelines and standards. All layers contained in Central Survey drawings will be defined as follows:

Discipline-Major-Minor-Desc-Phase

Table 1-A

Acronym	Description
Discipline	Discipline Code - V
Major	Major grouping of features that have common characteristics
Minor	Sub grouping of Major category
Description	Extended description of layers for clarity
Phase	Identification of the information's current status

Table 1-B

Code	Phase
EXAR	EXisting AeRial Mapping
EXSV	EXisting Survey Verified
EXUV	EXisting Un-Verified
EXTN	EXisting ToNed
OSAR	Out of Service AeRial Mapping
OSSV	Out of Service Survey Verified
OSUV	Out of Service Un-Verified
OSTN	Out of Service ToNed

EXAMPLE: V-SITE-WALL-STRU-EXSV

The Port Authority of New York and New Jersey Central Survey Group Layering Scheme consists of 12 major groups that correlate with spatial data layers to assist in the isolation of information for design purposes and for the translation and use with GIS. Although every attempt has been made to create an all-encompassing standard, reality dictates that additions will need to be made to the layer Scheme. In the case that additions are required, they will only be accepted as additions to minor or description categories and only when Request to Change Standard Form is supplied.

1.5.2 MULTI-LEVEL INFORMATION

The layer Scheme has been defined to support the use of a numeral at the end of the descriptor field to identify multi-level information. This is to accommodate those areas where ramps, bridges and overpasses must be identified. For example, an airport terminal with a departure ramp that is over the arrival area. In this case, the layer naming convention for all information relating to departures shall be suffixed with the numeral "1" to denote the first level of information over ground level. An example of the layer names is as follows:

EXAMPLE: V-PAVE-ROAD-ASPH1-EXSV

The numeral "1" following the descriptor "ASPH1" denotes that this is the first level of pavement above ground level.

1.5.3 ENTITY AND LAYER LINETYPES

All entities must have their linetype assigned "bylayer" not "byentity" with the exception that entities within symbols may have linetype assigned "byblock". For a complete list of linetypes provided refer **1.13 Appendix C - Linetypes**

1.5.4 ENTITY AND LAYER COLORS

All entities will be drawn on the specified layers and must have color assigned "bylayer" not "byentity" with the exception that entities within "blocks" may have color assigned "byblock". Layer color assignments are included in the layer definitions provided.

1.5.5 SYMBOLOGY

Symbols that consultants are to use in their AutoCAD drawings are available in this Standard. Each of the available symbols is illustrated in this publication. This symbology is based on current practices as well as symbology defined by the American National Standards Institute (ANSI) and other governing agencies.

The graphic representation of symbology in this Standard shows the relative proportion of the symbol. For a complete list of Symbols provided refer to **1.14 Appendix D – Symbols by Feature Set**.

1.5.5.1 SCALABLE SYMBOLS

Scalable symbols are created with the intent that they will appear the same size when plotted at different scales.

- Symbols are created on Layer "0" and will automatically take on the characteristics of the layer they are inserted on. All symbols will be inserted on the layer identified within this standard.
- For ease of use, the insertion scale factor of each scalable symbol will depend on the plot scale.

For Example: If the scale of the viewport is 1:30, then each symbol inserted in the drawing will be scaled up by a factor of 30.

1.5.5.2 NON-SCALABLE SYMBOLS

Non-Scalable symbols are created with the intent that they will appear at true size for all plot scales.

- Symbols are created on Layer “0” and will automatically take on the characteristics of the layer they are inserted on. All symbols will be inserted on the layer identified within this standard.
- The insertion scale factor for all Non-Scalable symbols will be “1”.

1.5.5.3 CREATING SYMBOLS

Symbols must be documented and supplied to the CAD committee in digital format as a single AutoCAD drawing file accompanied by a plot of the symbol and a Request to Change Standard Form found in section 1.18.

- Symbols will be created on Layer “0”. Other layers may be present in the drawing for supplemental information such as text within the symbol.
- Symbols will be created using the current version of AutoCAD software in use by the E/A Design Division.
- Colors and Linetypes will always be set to “bylayer”.
- Text within the symbol will utilize one of the Text Styles provided within this standard so that it is legible upon plotting.
- The symbol will be drawn so that the insertion point is located appropriately and is at 0,0,0.
- The “base” of the drawing will be set to 0,0,0.
- The symbol drawing will be purged of all unused blocks, layers, linetypes, text styles, etc.

1.5.6 PLOTTED LINEWEIGHTS

The colors used in the layer definitions provided within this standard correspond to plotted pen weights. AutoCAD products make use of a CTB file to assign pen weights to object colors. All E/A Design Division Contract Drawings are to be plotted using the “PA-Master.ctb” file that is provided with this standard. Many variables within the CTB file remain constant throughout the pen assignments, these variables are defined in **Table 1-C**. The pen numbers, lineweights and percent screening assigned to the pens used in the “PA-MasterFull.ctb” file are displayed in **Table 1-H**.

Table 1-C

Variable	Value
Color	Black
Dither	On
Virtual Pen Number	Automatic
Linetype	Use Object Linetype
Adaptive	On
Line End Style	Use Object End Style
Line Join Style	Miter
Fill Style	Use Object Fill Style

Central Survey Group CAD Standard

Pen	Color	Weight	Screen
1	Red	0.0100	100%
2	Yellow	0.0140	100%
3	Green	0.0200	100%
4	Cyan	0.0360	100%
5	Blue	0.0080	100%
6	Magenta	0.0240	100%
7	Black	0.0080	100%
8	Grey	0.0080	100%
9	Light Grey	0.0080	100%
10	Red	0.0140	100%
11	Light Red	0.0180	100%
12	Dark Red	0.0100	100%
13	Brown	0.0280	100%
14	Dark Brown	0.0080	100%
15	Light Brown	0.0140	100%
20	Orange	0.0180	100%
21	Light Orange	0.0080	100%
23	Dark Brown	0.0200	100%
24	Dark Brown	0.0320	100%
30	Orange	0.0400	100%
31	Light Orange	0.0080	100%
32	Dark Brown	0.0200	100%
33	Light Brown	0.0240	100%
35	Dark Brown	0.0240	100%
37	Dark Brown	0.0080	100%
40	Yellow	0.0200	100%
41	Light Yellow	0.0140	100%
42	Dark Yellow	0.0080	100%
43	Light Green	0.0240	100%
46	Dark Green	0.0040	100%
50	Yellow	0.0200	100%

Pen	Color	Weight	Screen
51	Light Yellow	0.0280	100%
52	Dark Yellow	0.0240	100%
53	Light Green	0.0040	100%
54	Dark Green	0.0100	100%
60	Light Green	0.0160	100%
61	Light Green	0.0100	100%
62	Dark Green	0.0080	100%
71	Light Green	0.0100	100%
80	Light Green	0.0100	100%
81	Light Green	0.0200	100%
82	Dark Green	0.0140	100%
83	Light Green	0.0080	100%
90	Light Green	0.0240	100%
92	Dark Green	0.0120	100%
93	Light Green	0.0080	100%
96	Dark Green	0.0100	100%
100	Light Green	0.0160	100%
110	Light Green	0.0080	100%
120	Cyan	0.0200	100%
121	Light Cyan	0.0140	100%
130	Light Cyan	0.0100	100%
131	Light Cyan	0.0200	100%
132	Dark Cyan	0.0040	100%
133	Light Cyan	0.0080	100%
140	Light Blue	0.0240	100%
141	Light Blue	0.0320	100%
142	Dark Blue	0.0180	100%
143	Light Blue	0.0080	100%
144	Dark Blue	0.0720	100%
148	Dark Blue	0.0100	30%
150	Light Blue	0.0280	100%

Pen	Color	Weight	Screen
170	Blue	0.0200	100%
172	Dark Blue	0.0240	100%
180	Dark Blue	0.0040	100%
190	Purple	0.0080	100%
191	Light Purple	0.0140	100%
192	Dark Purple	0.0240	100%
194	Dark Purple	0.0200	100%
200	Purple	0.0100	100%
201	Light Purple	0.0280	100%
202	Dark Purple	0.0100	100%
210	Purple	0.0160	100%
211	Light Purple	0.0320	100%
212	Dark Purple	0.0140	100%
220	Purple	0.0200	100%
221	Light Purple	0.0040	100%
222	Dark Purple	0.0100	100%
223	Light Purple	0.0040	100%
230	Purple	0.0160	100%
231	Light Purple	0.0240	100%
232	Dark Purple	0.0440	100%
234	Dark Purple	0.0160	100%
240	Red	0.0040	100%
241	Light Red	0.0080	100%
242	Dark Red	0.0040	100%
244	Dark Red	0.0080	100%
250	Black	0.0040	80%
251	Dark Grey	0.0080	70%
252	Grey	0.0080	60%
253	Light Grey	0.0080	50%
254	Very Light Grey	0.0040	40%
255	Very Light Grey	0.0480	100%

1.5.7 TEXT STYLE AND HEIGHTS

To promote consistency in Contract Drawings as well as prevent the use of “third-party” un-licensed AutoCAD font files, and to ensure a consistent plotted appearance of text, only ARIALN.TTF and ARIAL.TTF fonts are permitted for use on Central Survey Group Drawings.

Eight Text Styles have been provided as part of this standard. Three of the Text Styles provided (ARIAL, ARIALN, and Linetype) are used for Contract Border, Drawing Information or Linetype definitions and are not permitted for general use by the disciplines. The remaining five Text Styles provided, which are permitted for use by the disciplines are created as annotative styles. Annotative styles allow the AutoCAD product to scale the text heights appropriately based on the scale of the plotted drawing. The Text Styles provided are:

Text Style	Plotted Height	Annotative	Font	Description of Usage	Usable by Disciplines
PA – 0.10	0.10"	Yes	ARIAL.TTF	Normal Text	Yes
PA – 0.15	0.15"	Yes	ARIAL.TTF	Headings	Yes
PA – 0.20	0.20"	Yes	ARIAL.TTF	Titles	Yes
PA – 0.25	0.25"	Yes	ARIAL.TTF	Alternate Titles	Yes
Linetype	0.10"	No	RomanS.shx	Linetype Definitions	No
ARIAL	Varies	No	ARIAL.TTF	Contract Border and Drawing Info	No

Recommended text heights are defined below:

Use	Plotted Height
Major Titles	0.20"
Subtitles	0.15"
Notes, dimensions, etc.	0.10"
Point & Utility Labels	0.06" and 0.08"

Multi-Leader Style	Arrow Head	Content
PA-Arrow	Closed Filled Arrow	0.10" Mtext
PA-Loop	Open Loop	0.10" Mtext
PA-Circle	Dot Blank	0.10" Mtext
PA-Dot	Dot	0.10" Mtext
PA-Integral	Integral	0.10" Mtext
PA-DOT-Keynote-Box	Dot	Box
PA-DOT-Keynote-Circle	Dot	Circle
PA-DOT-Keynote-Hex	Dot	Hexagon

1.5.8 DRAWING UNITS AND PRECISION

All drawings shall be provided in decimal units with one drawing unit equal to one foot. Civil 3D drawings, Field book files and Land XML files are to have the Survey Units set to US Survey Foot.

1.5.9 COORDINATE SYSTEM

All drawings must be positioned on the local x-y grid with north defined straight up the page.

Files that are “attached” using AutoCAD’s XREF command should always use the coordinate 0,0 for two-dimensional files or 0,0,0 for three-dimensional files as the insertion point and a zero rotation angle.

Drawings submitted to the Central Survey Group should not have the User Coordinate Systems (UCS) defined. They should not be twisted with the “Dview” command and should be on a fixed coordinate system as defined by the Central Survey Group.

1.5.10 COORDINATE GRIDS

All drawing files shall be submitted with a coordinate grid drawn and labeled with northings and eastings. The basis for this grid will be determined by the Central Survey Group at the time of project award.

1.5.11 DRAWING ACCURACY

All entities that illustrate elements of construction must be input using dimensional data. Scanning, and/or digitizing are not an acceptable method of entry unless approved in advance by the Central Survey Group. Digitizing is allowed for site-oriented, non-construction features such as topography.

1.6 SHEET CREATION

All digital submittals are to adhere to the following standards. All drawing files submitted should be named based on the file naming conventions provided under the topic File Naming Conventions later in this document.

Drawings provided are to follow the following format. For mapping that will be provided on a single sheet, a border shall be inserted into the mapping drawing’s Layout1 environment. A view-port shall be created in Layout1 and the plan is to be “zoomed” to the appropriate scale. The Layout1 environment is to be plotted at a scale of 1 drawing unit = 1 paper inch and the Layout is to be renamed to match the sheet number of the sheet.

For mapping that will be submitted on from 2 to 6 sheets, up to 6 Layout tabs are to be created. Borders shall be inserted into each Layout tab in the mapping drawing. A view-port shall be created for each border and each view-port shall be “zoomed” to the appropriate area and scale. Each Layout tab shall be renamed to match the sheet number of the sheet being plotted from that tab.

For mapping that will be submitted on more than 6 sheets, a series of plot drawings shall be created. Each drawing shall contain a maximum of 6 Layout tabs. The mapping drawing shall be externally referenced to each plot drawing. A view-port shall be created for each border and each view-port shall be “zoomed” to the appropriate area and scale. Each Layout tab shall be renamed to match the sheet number of the sheet being plotted from that tab.

The drawing file shall be saved with the first Layout displayed.

1.6.1 USING THE REVISION BLOCK WITHIN THE CONTRACT BORDER

A revision block named “Drawing_Info – Stamp_Revision.dwg” has been provided with the CSG CAD Standard. When revisions are made, this block is to be inserted using an endpoint snap to the upper left corner of the previous revision line. Figure 1-D displays where the revision stamp is to be inserted. The stamp is located on the network at:

[Eng Operations Project Controls - VDC Group - VDC Documents - All Documents \(sharepoint.com\)](#)

Once inserted the revision block will prompt the user for information pertaining to the revision. Under no circumstances will the revision block be exploded or modified.

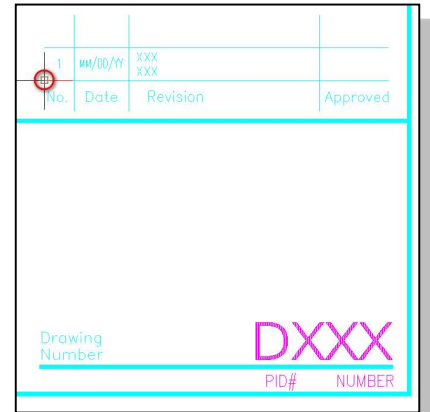

Figure 1-D

1.7 DATA COLLECTION PRACTICES AND PROCEDURES

1.7.1 DESCRIPTION KEYS

Field data collection codes formatted for Civil 3D are provided in this standard. The Data Collection codes are configured to support the symbols and Layers defined in this standard. For a complete list of Description Keys refer to **1.12 Appendix B - Field Description Code**.

1.8 AERIAL MAPPING REQUIREMENTS

These requirements support the Port Authority’s continuing effort to organize, consolidate, and standardize the information generated and consumed by the all divisions within the agency. The objective of these requirements is to make the data files easier for users to identify and integrate in planning and design.

1.8.1 COORDINATE SYSTEM

All submissions should include a data set that is in the Port Authority standard coordinate system for that particular facility (State Plane, NAD 1983).

1.8.2 SECTOR GRID

The Central Survey Group prior to the mapping capture will supply a defined sector grid. Included in the deliverable should be the mapping, CAD drawings and image files, as a whole (Overall) and divided into the sector grid supplied.

1.8.3 AERIAL PHOTOGRAPHS

Georeferenced aerial photograph data sets should be submitted in .ecw and .jpg format and should include georeferencing files (“world files”) for each image file.

1.8.4 FILE NAMES

Files that are delivered in the form of a data set broken up into sectors should be named according to the following guidelines:

The name of each file should include:

- a) The CSG hold number
- b) The facility code
- c) The date the data was captured as an 8 digit code YYYYMMDD (January 28, 2018 would be represented as 20180128)
- d) The abbreviation for the coordinate system that the data is in using the AutoCAD MAP abbreviations.
- e) The sector name

Example: 2018-125_EWR_20180128-NJ83_106-126.dwg

1.9 DIGITAL SUBMITTAL REQUIREMENTS

This Standard adopts AutoCAD Civil 3D as the “Standard CAD Software”. Even so, AutoCAD is in no way endorsed over any other product and there is no requirement that consultants use AutoCAD software to draft their design. Consultants may prepare their drawings using the CAD software of their choice but deliverables must be AutoCAD (.dwg) files that conform to the standards and procedures set forth by this document. Additionally, softcopy (CAD files) must include all information presented on the hardcopy (plots). This precludes the use of stick-back, graphic tapes, hand lettering and anything else which is placed on the drawing after it is plotted excepting any signatures and seals.

1.9.1 CAD FILE FORMAT

All digital CAD files shall be compatible with the release of AutoCAD currently used by the PANYNJ. When submitting files on electric media, the version of AutoCAD is to be noted. All project data (i.e. field notes, photos, survey control, etc.) used to create any drawing content is to accompany all CAD files submitted. If AutoCAD is not used to create the drawing content, all alignment, terrain model, profile, geometry point and pipe network data is to be supplied in LANDXML format. Geometry point data can also be supplied in the ascii (PNEZD) comma delimited file format.

1.9.2 CIVIL 3D UTILITY SUBMITTALS

Consultants are required to submit utility data in the form of 3D linework. The following items are acceptable as 3D linework: 3D Polylines to represent utility lines and CAD blocks to represent utility structures, Civil 3D Feature Lines to represent utility lines and CAD blocks to represent utility structures, Civil 3D Pipe Networks to represent utility lines and utility structures. The 3D linework must be drawn to simulate the utilities as the data was gathered in the field, i.e. each survey shot along a utility line will represent a 3D vertex on the 3D linework at the elevation gathered from the survey shot (with the exception of “SUE”, Subsurface Utility Engineering, paint marks at grade. Utilities with unknown elevation shall be drawn as 2D linework with an elevation of 0.00).

1.9.3 SUBMITTAL REQUIREMENTS

Consultants are required to submit digital CAD files (softcopy) concurrent with each hardcopy submittal. Refer to individual contracts/survey requests for specific submittal schedules. DWG and PDF files are required for each submittal.

1.9.4 HARDCOPY SUBMITTALS

Final hardcopies of each sheet must use the PANYNJ Contract Border identified in this standard and must be submitted at full size, either 22x34 or 34x56. Submitted hardcopies must use archival paper with Permalife® plotter paper specifications. The Port Authority Engineering Department staff will verify that submissions contain the “Permalife 25% cotton content” watermark.

Please refer to **1.16 Appendix F – Contract Borders**

1.9.5 DIGITAL MEDIA SUBMITTALS

Digital media (thumbdrive, external harddrive, CD’s, DVD’s) are only accepted for submittals when file size exceeds 500MB and acknowledgement has been given by the Port Authority. All digitally submitted media must be labeled with the following information:

- Consultant’s name and Survey Request Number (SRN)
- Contact name and phone number of consulting project manager/task manager
- Discipline-Facility-General Location (e.g. Central Survey-JFK-Howard Beach)
- Submittal Date
- Data Format (e.g. AutoCAD Version .dwg)
- File Name(s)

1.9.6 PROJECT WEBSITE (LIVELINK) SUBMITTALS

The PANYNJ has developed a “Project Extranet” to enhance collaboration between in-house surveyors and outside consultants, as well as with different departments and divisions throughout the agency. All Project Websites have a folder structure similar to that described in **1.3 Accessing the CSG CAD Standard** in this standard.

Please refer to the project specifics to determine if a Project Website is available for use. If so, all transfer of digital information will be made via the website. If a Project Website is available for the project the Project Website link will be provided along with a Username and a Password.

1.10 CONCLUSION

This document is a comprehensive standard for the creation of contract drawings for the Central Survey Group of the Port Authority. All drawings submitted to the Central Survey Group must adhere to the conventions documented here.

1.11 APPENDIX A – LAYER STRATEGEM

1.11.1 ALIGNMENTS

Discipline	Major	Minor	Desc	Phase	Color	Linetype	Description
V	ALGN	HOR			131	Center2	Road/Taxiway/Runway Edge Alignments
V	ALGN	BRNG			1	Continuous	Bearings
V	ALGN	DSPD			131	Continuous	Alignment Design Speed
V	ALGN	PCPT			100	Continuous	Pc/Pt/Pcc/Prc/Poc Bubbles And Text
V	ALGN	STAT			100	Continuous	Alignment Stations And Text

V	ALGN	THEO			1	Continuous	Alignment Theoretic
V	ALGN	TPRD			131	Continuous	Temporary Road Alignments

1.11.2 BUILDINGS

Discipline	Major	Minor	Desc	Phase	Color	Linetype	Description
V	BLDG	ACCR			1	Continuous	Patio, Roof Details, Shed & Stairs
V	BLDG	ACCR	SWMP		5	Continuous	Swimming Pool
V	BLDG	ACCR	TEXT		1	Continuous	Roof Detail Text
V	BLDG	COLM			7	Continuous	Column Line
V	BLDG	COLM	SYMB		7	Continuous	Column
V	BLDG	COLM	TEXT		7	Continuous	Column Text
V	BLDG	OTLN			13	Continuous	Building Outline
V	BLDG	OTLN	METR		13	Continuous	Meter House
V	BLDG	OTLN	TEXT		13	Continuous	Building Outline Text
V	BLDG	ROOF			13	Continuous	Building Roof Line, Roof Line

1.11.3 CONTROL

Discipline	Major	Minor	Desc	Phase	Color	Linetype	Description
V	CTRL	GRID	27NE		8	Continuous	Control Grid NYE NAD27 & Text
V	CTRL	GRID	27NJ		8	Continuous	Control Grid NJ NAD27 & Text
V	CTRL	GRID	83LI		8	Continuous	Control Grid LI NAD83 & Text
V	CTRL	GRID	83NE		8	Continuous	Control Grid NYE NAD83 & Text
V	CTRL	GRID	83NJ		8	Continuous	Control Grid NJ NAD83 & Text
V	CTRL	GRID	BGRT		8	Continuous	Control Grid Bogart & Text
V	CTRL	GRID	MMCH		8	Continuous	Control Grid Memorial Church & Text
V	CTRL	GRID	NODT		8	Continuous	Control Grid No Datum & Text
V	CTRL	GRID	QUEN		8	Continuous	Control Grid Queens System & Text
V	CTRL	PNTS	AHCP		200	Continuous	Aerial Horizontal Control Point & Text
V	CTRL	PNTS	AVCP		200	Continuous	Aerial Vertical Control Point & Text
V	CTRL	PNTS	HSCP		200	Continuous	Horizontal Control Point & Text
V	CTRL	PNTS	HVCP		200	Continuous	Horizontal & Vertical Control Point & Text
V	CTRL	PNTS	VSCP		8	Continuous	Vertical Control Point & Text

1.11.4 ENVIRONMENTAL

Discipline	Major	Minor	Desc	Phase	Color	Linetype	Description
V	ENVR	BORE	SYMB		7	Continuous	Bore Hole
V	ENVR	HAZR			31	Continuous	Edge of Hazard
V	ENVR	MONW	SYMB		7	Continuous	Monitoring Well
V	ENVR	MONW	TEXT		7	Continuous	Monitoring Well Text
V	ENVR	PHRG			5	Continuous	Edge of Phragmites
V	ENVR	SETP			7	Continuous	Settling Point
V	ENVR	WETL			5	Continuous	Wetland Flag
V	ENVR	WETL	SYMB		5	Continuous	Wetland Flag
V	ENVR	WETL	TEXT		5	Continuous	Wetland Flag Text

1.11.5 GENERAL

Discipline	Major	Minor	Desc	Phase	Color	Linetype	Description
V	GNRL	CERT	SYMB		7	Continuous	General Certification
V	GNRL	CERT	TEXT		7	Continuous	General Certification Text
V	GNRL	MTCH			5	Continuous	Matchline
V	GNRL	NOTE	SYMB		7	Continuous	North Arrow & Bar
V	GNRL	NOTE	TEXT		7	Continuous	General Note Text
V	GNRL	TBLK	TEXT		7	Continuous	General Titleblock
V	GNRL	VPRT			7	Continuous	Viewport
V	GNRL	VPRT	TEXT		7	Continuous	Viewport Text
V	GNRL	XREF			7	Continuous	All Ext. References

1.11.6 HYSOGRAPHY

Discipline	Major	Minor	Desc	Phase	Color	Linetype	Description
V	HYPS	BOTS			7	Bot	Bottom of Slope or Bank
V	HYPS	CLBL			13	Continuous	Contour Label
V	HYPS	DTMP			13	Continuous	Surface TIN Line
V	HYPS	DTMP	BRDR		13	Continuous	Digital Terrain Model Border
V	HYPS	DTMP	SYMB		7	Continuous	Digital Terrain Model
V	HYPS	FEAT			131	Continuous	Feature Line
V	HYPS	FHAL			92	Continuous	Mass Haul Free Haul
V	HYPS	FHAL	PATT		172	Continuous	Mass Haul Free Haul Pattern
V	HYPS	GRAD	CUT		200	Continuous	Grading Cut Material
V	HYPS	GRAD	FIL		1	Continuous	Grading Fill Material
V	HYPS	GRAD	OBJ		121	Continuous	Grading Object
V	HYPS	GRAD	CUTP		200	Continuous	Grading Cut Material Pattern
V	HYPS	GRAD	FILP		1	Continuous	Grading Fill Material Pattern
V	HYPS	GRAD	PATT		92	Continuous	Grading Pattern
V	HYPS	GRID			121	Continuous	Grid Surface
V	HYPS	GRID	ASPH		8	Continuous	Grid Shot – Asphalt
V	HYPS	GRID	CONC		8	Continuous	Grid Shot – Concrete
V	HYPS	GRID	GRSS		8	Continuous	Grid Shot – Grass
V	HYPS	GRID	GRVL		8	Continuous	Grid Shot – Gravel
V	HYPS	MAJR			13	Continuous	Major Contour
V	HYPS	MAJR	TEXT		13	Continuous	Major Contour Text
V	HYPS	MHAL			12	Continuous	Mass Haul
V	HYPS	MHAL	GRID		8	Continuous	Mass Haul Grid Line
V	HYPS	MHAL	TEXT		12	Continuous	Mass Haul Text
V	HYPS	MINR			252	Continuous	Minor Contour
V	HYPS	MINR	TEXT		252	Continuous	Minor Contour Text
V	HYPS	MJRD			13	Continuous	Depression Major Contour
V	HYPS	MJRD	TEXT		13	Continuous	Depression Major Contour Text
V	HYPS	MNRD			252	Continuous	Depression Minor Contour
V	HYPS	MNRD	TEXT		252	Continuous	Depression Minor Contour Text
V	HYPS	OHAL	PATT		100	Continuous	Mass Haul Over Haul Pattern
V	HYPS	SCTN			12	Continuous	Grading Section
V	HYPS	SLOP			12	Continuous	Surface Slope
V	HYPS	SPOT	SYMB		7	Continuous	Spot Shot
V	HYPS	TEXT			12	Continuous	Miscellaneous Text
V	HYPS	TOPS			7	Top	Top of Slope or Bank
V	HYPS	USER			12	Continuous	Surface User Defined Contour
V	HYPS	WSHD			13	Continuous	Surface Watershed
V	HYPS	WSHD	TEXT		13	Continuous	Surface Watershed Text

1.11.7 LEGAL

Discipline	Major	Minor	Desc	Phase	Color	Linetype	Description
V	LEGL	BULK			231	Phantom2	Bulkhead Lines
V	LEGL	BULK	SYMB		231	Continuous	Bulkhead
V	LEGL	BULK	TEXT		7	Continuous	Bulkhead Text
V	LEGL	EASE			231	Phantom2	Easement Lines
V	LEGL	EASE	TEXT		7	Continuous	Easement Lines Text
V	LEGL	LEAS			231	Phantom2	Lease Lines
V	LEGL	LEAS	TEXT		7	Continuous	Lease Text
V	LEGL	PIER			231	Phantom2	Pierhead Lines
V	LEGL	PIER	SYMB		231	Continuous	Pierhead
V	LEGL	PIER	TEXT		7	Continuous	Pierhead Text
V	LEGL	PROP			231	Phantom2	Property Lines
V	LEGL	PROP	TEXT		7	Continuous	Property Lines Text
V	LEGL	ROW			231	Phantom2	Right of Way
V	LEGL	ROW	TEXT		7	Continuous	Right of Way Text
V	LEGL	TENN			231	Phantom2	Tenant Lines
V	LEGL	TENN	TEXT		7	Continuous	Tenant Lines Text

1.11.8 MARKINGS

Discipline	Major	Minor	Desc	Phase	Color	Linetype	Description
V	MARK	APRN			7	Continuous	Apron Pavement Markings
V	MARK	LINE	BWL		7	DashedX2	Broken White Line
V	MARK	LINE	BYL		2	DashedX2	Broken Yellow Line
V	MARK	LINE	FBL		5	Continuous	Full Blue Line
V	MARK	LINE	FWL		7	Continuous	Full White Line
V	MARK	LINE	FYL		2	Continuous	Full Yellow Line
V	MARK	LINE	RUNC		7	Continuous	Runway Centerline
V	MARK	LINE	RUND		7	DashedX2	Runway Dashed Edge Line
V	MARK	LINE	RUNS		7	Continuous	Runway Solid Edge Line
V	MARK	LINE	STOP		7	Continuous	Solid Stop Line
V	MARK	LINE	TAXC		7	Continuous	Taxiway Centerline
V	MARK	LINE	TAXD		7	DashedX2	Taxiway Dashed Edge Line
V	MARK	LINE	TAXS		7	Continuous	Taxiway Solid Edge Line
V	MARK	SYMB	ARWS		7	Continuous	Directional Arrow Symbols
V	MARK	SYMB	HAND		5	Continuous	Handicapped Symbol
V	MARK	SYMB	RUNW		7	Continuous	Miscellaneous Runway Markings
V	MARK	SYMB	TEXT		5	Continuous	Painted Text ("ONLY", "STOP")

1.11.9 PAVEMENT

Discipline	Major	Minor	Desc	Phase	Color	Linetype	Description
V	PAVE	APRN	ASPH		200	Continuous	Edge of Apron – Asphalt
V	PAVE	APRN	CONC		7	Continuous	Edge of Apron - Concrete
V	PAVE	ASPH			200	Continuous	Edge of Pavement – Asphalt
V	PAVE	BRDG	STL		252	Continuous	Bridge – Steel
V	PAVE	BRDG	CONC		7	Continuous	Bridge – Concrete
V	PAVE	CBAR			7	Continuous	Jersey or Concrete Barrier
V	PAVE	CBMP	SYMB		7	Continuous	Concrete Bumper

V	PAVE	CONC			7	Continuous	Edge of Pavement – Concrete
V	PAVE	CRBB			200	Continuous	Bottom of Curb
V	PAVE	CRBT			7	Continuous	Top of Curb
V	PAVE	CRCK			7	Continuous	Pavement Cracks
V	PAVE	DCUB			7	Hidden	Drop Curb
V	PAVE	DLIN	SYMB		7	Continuous	Delineator
V	PAVE	DUCT	SYMB		7	Continuous	Super Duct – Traffic Guide
V	PAVE	GRVL			200	Continuous	Edge of Pavement – Gravel
V	PAVE	GUTR			7	Continuous	Gutter
V	PAVE	HAND	SYMB		5	Continuous	Handicapped Ramp
V	PAVE	IMPA			13	Continuous	Impact Attenuator
V	PAVE	JONT			80	Continuous	Joints
V	PAVE	NAME			7	Continuous	Road Name Annotation
V	PAVE	REFL	SYMB		7	Continuous	Reflector
V	PAVE	SBMP			251	Continuous	Speed Bump
V	PAVE	TRAL			200	Dashed	Centerline of Trail
V	PAVE	UNPV			200	Continuous	Edge of Pavement – Unpaved
V	PAVE	WALK			7	Continuous	Sidewalk

1.11.10 PROFILES

Discipline	Major	Minor	Desc	Phase	Color	Linetype	Description
V	PROF				131	Continuous	Profile Features
V	PROF	EGL			172	Continuous	Energy Grade Line
V	PROF	HGL			100	Dashed	High Grade Line
V	PROF	GRID			250	Continuous	Profile View Grid Line
V	PROF	GRID	CUT		1	Continuous	Profile View Cut
V	PROF	GRID	FIL		130	Continuous	Profile View Fill
V	PROF	OFST			92	Dashed	Offset Profile
V	PROF	TEXT			100	Continuous	Misc. Text & Callouts With Assoc. Leader Lines
V	PROF	THEO			1	Continuous	Theoretic Profile Feature

1.11.11 RAILROAD

Discipline	Major	Minor	Desc	Phase	Color	Linetype	Description
V	RLRD	BBAL			1	Bbal	Bottom of Ballast
V	RLRD	CLIN			1	Center	Track Centerline
V	RLRD	ELEC	SYMB		1	Continuous	Trip Box
V	RLRD	MISC	SYMB		1	Continuous	Miscellaneous Rail Symbols
V	RLRD	POWR			1	Power	Power Rail
V	RLRD	PTOF	SYMB		1	Continuous	Point of Frog
V	RLRD	PTOS	SYMB		1	Continuous	Point of Switch
V	RLRD	TBAL			1	Tbal	Top of Ballast
V	RLRD	TRCK			1	RR	Track Line
V	RLRD	TRCK	TEXT		1	Continuous	Track Line Annotations

1.11.12 SECTIONS

Discipline	Major	Minor	Desc	Phase	Color	Linetype	Description
V	SECT				172	Continuous	Section Features

V	SECT	GRID			250	Continuous	Section View Grid Line
V	SECT	SMPL			131	Continuous	Section Sample Line Along Alignment
V	SECT	SMPL	TEXT		100	Continuous	Section Sample Line Text
V	SECT	SMPL	VRTX		92	Continuous	Section Sample Vertex
V	SECT	TEXT			100	Continuous	Section Label
V	SECT	VIEW			250	Continuous	Section View
V	SECT	VRTX			1	Continuous	Section Vertex
V	SECT	XING			1	Center2	Section Crossing
V	SECT	XING	OFST		1	Center2	Section Crossing Offset

1.11.13 SIGN

Discipline	Major	Minor	Desc	Phase	Color	Linetype	Description
V	SIGN	GNRL			31	Continuous	General Sign Lines
V	SIGN	GNRL	SYMB		31	Continuous	General Sign Symbols
V	SIGN	GUID	SYMB		31	Continuous	Guide Signs
V	SIGN	INFO	SYMB		31	Continuous	Informational Signs
V	SIGN	LABL	SYMB		31	Continuous	Sign Labels
V	SIGN	OBJM	SYMB		31	Continuous	Sign Object Marker
V	SIGN	REGU	SYMB		31	Continuous	Regulatory Signs
V	SIGN	RUNW	SYMB		31	Continuous	Runway Signs
V	SIGN	VMSS	SYMB		31	Continuous	Variable Message Signs
V	SIGN	WARN	SYMB		31	Continuous	Warning Signs

1.11.14 SITE WORK

Discipline	Major	Minor	Desc	Phase	Color	Linetype	Description
V	SITE	STL			7	Continuous	Edge of Steel
V	SITE	BARL	SYMB		7	Continuous	Sand Filled Barrel
V	SITE	CONC			7	Continuous	Concrete Pads / Edge of Concrete
V	SITE	FENC			7	Fen	Fence Line
V	SITE	FENC	BLST		7	Continuous	Blast Fence
V	SITE	FENC	BXBM		7	GuideB	Guide Rail – Box Beam
V	SITE	FENC	HDRL		7	Continuous	Hand Rail
V	SITE	FENC	SYMB		7	Continuous	Miscellaneous Fence Symbols
V	SITE	FENC	TBEM		7	GuideT	Guide Rail – Thrie Beam
V	SITE	FENC	WBEM		7	GuideW	Guide Rail – W Beam
V	SITE	GRVL			7	Continuous	Edge of Gravel
V	SITE	MISC			7	Continuous	Miscellaneous Site Line Work
V	SITE	MISC	SYMB		7	Continuous	Miscellaneous Site Symbols
V	SITE	MRSH			5	Dashed	Marsh or Swamp Lines
V	SITE	PERM	SYMB		7	Continuous	Permanent Site Feature Symbols
V	SITE	ROCK			31	Rock	Rock Outcrop
V	SITE	RRAP			80	Dot2	Edge of Rip Rap
V	SITE	STNE			7	Continuous	Edge of Stone
V	SITE	TEMP			7	Continuous	Temporary Site Feature Line Work
V	SITE	TEMP	SYMB		7	Continuous	Temporary Site Feature Symbols
V	SITE	TEXT			7	Continuous	Site Annotations
V	SITE	VEGE	HDGE		80	Hedge	Hedge Lines
V	SITE	VEGE	SYMB		80	Continuous	Vegetation Symbols
V	SITE	VEGE	TREE		80	Tree	Tree Lines
V	SITE	WALL			31	Continuous	General Walls
V	SITE	WALL	BTM		31	Continuous	Bottom of Wall
V	SITE	WALL	MRNE		31	Continuous	Boat Ramp
V	SITE	WALL	ROCK		31	Continuous	Stone Wall

V	SITE	WALL	RTOP		31	Continuous	Top of Retaining Wall
V	SITE	WALL	STRU		31	Continuous	Abutment
V	SITE	WATR			5	Continuous	Edge of Water
V	SITE	WATR	WHRF		7	Continuous	Wharf

1.11.15 UTILITIES

Discipline	Major	Minor	Desc	Phase	Color	Linetype	Description
V	UTIL				7	Continuous	Miscellaneous Utility Lines
V	UTIL	AIRL			5	Air	Air Lines
V	UTIL	AIRL	SYMB		5	Continuous	Air Line Symbols
V	UTIL	AIRL	TEXT		7	Continuous	Air Line Annotations
V	UTIL	CCTV			42	Continuous	Closed Circuit Television Lines
V	UTIL	CFAA			42	Comm Faa	FAA Lines
V	UTIL	CFAA	SYMB		42	Continuous	FAA Line Symbols
V	UTIL	CFAA	TEXT		7	Continuous	FAA Line Annotations
V	UTIL	CFIR			42	Comm Fire	Fire Lines
V	UTIL	CFIR	SYMB		42	Continuous	Fire Line Symbols
V	UTIL	CFIR	TEXT		7	Continuous	Fire Line Annotations
V	UTIL	CFOC			31	Foc	Fiber Optic Cable Lines
V	UTIL	CFOC	SYMB		31	Continuous	Fiber Optic Cable Line Symbols
V	UTIL	CFOC	TEXT		7	Continuous	Fiber Optic Cable Line Annotations
V	UTIL	CHIL			5	CHW	Chilled Water Lines
V	UTIL	CHIL	PATT		5	Continuous	Chilled Water Line Pattern
V	UTIL	CHIL	SYMB		5	Continuous	Chilled Water Line Symbols
V	UTIL	CHIL	TEXT		7	Continuous	Chilled Water Line Annotations
V	UTIL	CHIL	WALL		5	Continuous	Chilled Water Line Walls
V	UTIL	COMB			80	Continuous	Combined Lines
V	UTIL	COMB	SYMB		80	Continuous	Combined Water Line Symbols
V	UTIL	COMB	TEXT		7	Continuous	Combined Water Line Annotations
V	UTIL	COMM			31	Comm	Communication Lines
V	UTIL	COMM	DTBK		7	Hidden	Communication Line Duct Bank
V	UTIL	COMM	DTBK	EXSV	7	Hidden	Existing Survey Verified
V	UTIL	COMM	DTBK	EXTN	7	Hidden	Existing Toned
V	UTIL	COMM	DTBK	EXUV	7	Hidden	Existing Unverified
V	UTIL	COMM	DTBK	OSSV	7	Hidden	Out-of-Service Survey Verified
V	UTIL	COMM	DTBK	OSTN	7	Hidden	Out-of-Service Toned
V	UTIL	COMM	DTBK	OSUV	7	Hidden	Out-of-Service Unverified
V	UTIL	COMM	PATT		31	Continuous	Communication Line Pattern
V	UTIL	COMM	SYMB		31	Continuous	Communication Line Symbols
V	UTIL	COMM	TEXT		7	Continuous	Communication Line Annotations
V	UTIL	COMM	WALL		31	Continuous	Communication Line Walls
V	UTIL	CSEC			31	Comm Sec	Security Lines
V	UTIL	CSEC	SYMB		31	Continuous	Security Line Symbols
V	UTIL	CSEC	TEXT		7	Continuous	Security Line Annotations
V	UTIL	CTEL			31	Comm Tele	Telephone Lines
V	UTIL	CTEL	SYMB		31	Continuous	Telephone Line Symbols
V	UTIL	CTEL	TEXT		7	Continuous	Telephone Line Annotations
V	UTIL	CTLV			42	Comm Tv	Cable Television Lines
V	UTIL	CTLV	SYMB		42	Continuous	Cable Television Line Symbols
V	UTIL	CTLV	TEXT		7	Continuous	Cable Television Line Annotations
V	UTIL	CTRF			31	Comm Traf	Traffic Control Device Lines
V	UTIL	CTRF	SYMB		31	Continuous	Traffic Control Device Line Symbols
V	UTIL	CTRF	TEXT		7	Continuous	Traffic Control Device Line Annotations
V	UTIL	DRAN			80	Drain	Storm Drainage Lines
V	UTIL	DRAN	PATT		80	Continuous	Storm Drainage Pattern
V	UTIL	DRAN	SYMB		80	Continuous	Storm Drainage Line Symbols
V	UTIL	DRAN	TDRN		80	Trench	Trench Drainage Lines
V	UTIL	DRAN	TEXT		7	Continuous	Storm Drainage Line Annotations
V	UTIL	DRAN	WALL		80	Continuous	Storm Drainage Walls

Central Survey Group CAD Standard

V	UTIL	EL05			1	5KV	5 KV Electric Lines
V	UTIL	EL05	DTBK		7	Hidden	5 KV Electric Line Duct Bank
V	UTIL	EL05	DTBK	EXSV	7	Hidden	Existing Survey Verified
V	UTIL	EL05	DTBK	EXTN	7	Hidden	Existing Toned
V	UTIL	EL05	DTBK	EXUV	7	Hidden	Existing Unverified
V	UTIL	EL05	DTBK	OSSV	7	Hidden	Out-of-Service Survey Verified
V	UTIL	EL05	DTBK	OSTN	7	Hidden	Out-of-Service Toned
V	UTIL	EL05	DTBK	OSUV	7	Hidden	Out-of-Service Unverified
V	UTIL	EL05	PATT		1	Continuous	5 KV Electric Line Pattern
V	UTIL	EL05	SYMB		1	Continuous	5 KV Electric Line Symbols
V	UTIL	EL05	TEXT		7	Continuous	5 KV Electric Line Annotations
V	UTIL	EL05	WALL		1	Continuous	5 KV Electric Line Walls
V	UTIL	EL13			1	13.8KV	13.8 KV Electric Lines
V	UTIL	EL13	DTBK		7	Hidden	13.8 KV Electric Line Duct Bank
V	UTIL	EL13	DTBK	EXSV	7	Hidden	Existing Survey Verified
V	UTIL	EL13	DTBK	EXTN	7	Hidden	Existing Toned
V	UTIL	EL13	DTBK	EXUV	7	Hidden	Existing Unverified
V	UTIL	EL13	DTBK	OSSV	7	Hidden	Out-of-Service Survey Verified
V	UTIL	EL13	DTBK	OSTN	7	Hidden	Out-of-Service Toned
V	UTIL	EL13	DTBK	OSUV	7	Hidden	Out-of-Service Unverified
V	UTIL	EL13	SYMB		1	Continuous	13.8 KV Electric Line Symbols
V	UTIL	EL13	TEXT		7	Continuous	13.8 KV Electric Line Annotations
V	UTIL	EL27			1	27KV	27 KV Electric Lines
V	UTIL	EL27	DTBK		7	Hidden	27 KV Electric Line Duct Bank
V	UTIL	EL27	DTBK	EXSV	7	Hidden	Existing Survey Verified
V	UTIL	EL27	DTBK	EXTN	7	Hidden	Existing Toned
V	UTIL	EL27	DTBK	EXUV	7	Hidden	Existing Unverified
V	UTIL	EL27	DTBK	OSSV	7	Hidden	Out-of-Service Survey Verified
V	UTIL	EL27	DTBK	OSTN	7	Hidden	Out-of-Service Toned
V	UTIL	EL27	DTBK	OSUV	7	Hidden	Out-of-Service Unverified
V	UTIL	EL27	PATT		1	Continuous	27 KV Electric Line Pattern
V	UTIL	EL27	SYMB		1	Continuous	27 KV Electric Line Symbols
V	UTIL	EL27	TEXT		7	Continuous	27 KV Electric Line Annotations
V	UTIL	EL27	WALL		1	Continuous	27 KV Electric Line Walls
V	UTIL	ELCP			1	ELCP	Electric Cathodic Protection Lines
V	UTIL	ELCP	DTBK	EXSV	7	Hidden	Existing Survey Verified
V	UTIL	ELCP	DTBK	EXTN	7	Hidden	Existing Toned
V	UTIL	ELCP	DTBK	EXUV	7	Hidden	Existing Unverified
V	UTIL	ELCP	DTBK	OSSV	7	Hidden	Out-of-Service Survey Verified
V	UTIL	ELCP	DTBK	OSTN	7	Hidden	Out-of-Service Toned
V	UTIL	ELCP	DTBK	OSUV	7	Hidden	Out-of-Service Unverified
V	UTIL	ELCP	SYMB		7	Hidden	Electric Cathodic Protection Line Symbols
V	UTIL	ELCP	TEXT		7	Continuous	Electric Cathodic Protection Line Annotations
V	UTIL	ELCP	WALL		1	Continuous	Electric Cathodic Protection Line Walls
V	UTIL	ELEC			1	Elec	Electric Lines
V	UTIL	ELEC	DTBK		1	Continuous	Electric Line Duct Bank
V	UTIL	ELEC	DTBK	EXSV	1	Continuous	Existing Survey Verified
V	UTIL	ELEC	DTBK	EXTN	14	Continuous	Existing Toned
V	UTIL	ELEC	DTBK	EXUV	241	Continuous	Existing Unverified
V	UTIL	ELEC	DTBK	OSSV	1	Continuous	Out-of-Service Survey Verified
V	UTIL	ELEC	DTBK	OSTN	14	Continuous	Out-of-Service Toned
V	UTIL	ELEC	DTBK	OSUV	241	Continuous	Out-of-Service Unverified
V	UTIL	ELEC	PATT		1	Continuous	Electric Line Pattern
V	UTIL	ELEC	SYMB		1	Continuous	Electric Line Symbols
V	UTIL	ELEC	TEXT		7	Continuous	Electric Line Annotations
V	UTIL	ELEC	WALL		1	Continuous	Electric Line Walls
V	UTIL	FLDI			200	Dsl	Diesel Lines
V	UTIL	FLDI	SYMB		200	Continuous	Diesel Line Symbols
V	UTIL	FLDI	TEXT		7	Continuous	Diesel Line Annotations
V	UTIL	FLGS			200	Gsl	Gasoline Lines
V	UTIL	FLGS	SYMB		200	Continuous	Gasoline Line Symbols
V	UTIL	FLGS	TEXT		7	Continuous	Gasoline Line Annotations
V	UTIL	FLJT			200	Jet	Jet Fuel Lines
V	UTIL	FLJT	SYMB		200	Continuous	Jet Fuel Line Symbols

Central Survey Group CAD Standard

V	UTIL	FLJT	TEXT		7	Continuous	Jet Fuel Line Annotations
V	UTIL	FLPG			200	Ppg	Propane Gas Fuel Lines
V	UTIL	FLPG	SYMB		200	Continuous	Propane Gas Fuel Line Symbols
V	UTIL	FLPG	TEXT		7	Continuous	Propane Gas Fuel Line Annotations
V	UTIL	FOAM			5	Foam	Foam Lines
V	UTIL	FOAM	SYMB		5	Continuous	Foam Line Symbols
V	UTIL	FOAM	TEXT		7	Continuous	Foam Line Annotations
V	UTIL	FUEL			61	Fuel	Fuel Lines
V	UTIL	FUEL	SYMB		61	Continuous	Fuel Line Symbols
V	UTIL	FUEL	TEXT		7	Continuous	Fuel Line Annotations
V	UTIL	GENR	SYMB		7	Continuous	Generic Utility Symbols
V	UTIL	NGAS			2	Gas	Natural Gas Lines
V	UTIL	NGAS	PATT		2	Continuous	Natural Gas Line Pattern
V	UTIL	NGAS	SYMB		61	Continuous	Natural Gas Line Symbols
V	UTIL	NGAS	TEXT		7	Continuous	Natural Gas Line Annotations
V	UTIL	NGAS	WALL		2	Continuous	Natural Gas Line Walls
V	UTIL	OHWR			42	Ohw	Overhead Wire
V	UTIL	SSWR			84	San	Sanitary Sewer Lines
V	UTIL	SSWR	PATT		84	Continuous	Sanitary Sewer Line Pattern
V	UTIL	SSWR	SYMB		84	Continuous	Sanitary Sewer Line Symbols
V	UTIL	SSWR	TEXT		7	Continuous	Sanitary Sewer Line Annotations
V	UTIL	SSWR	WALL		84	Continuous	Sanitary Sewer Line Walls
V	UTIL	STEM			7	Steam	Steam Lines
V	UTIL	STEM	SYMB		7	Continuous	Steam Line Symbols
V	UTIL	STEM	TEXT		7	Continuous	Steam Line Annotations
V	UTIL	SYMB			7	Continuous	Miscellaneous Utility Symbols
V	UTIL	TDSL			5	Tds	Thermal Distribution System Lines
V	UTIL	TDSL	SYMB		5	Continuous	Thermal Distribution System Line Symbols
V	UTIL	TDSL	TEXT		7	Continuous	Thermal Distribution System Line Annotations
V	UTIL	TEXT			7	Continuous	Miscellaneous Utility Annotations
V	UTIL	TEXT	XING		7	Continuous	Miscellaneous Utility Crossing Text
V	UTIL	UKWN			7	Unk	Unknown Utility Lines
V	UTIL	UKWN	PATT		7	Continuous	Unknown Utility Lines Pattern
V	UTIL	UKWN	SYMB		7	Continuous	Unknown Utility Line Symbols
V	UTIL	UKWN	TEXT		7	Continuous	Unknown Utility Line Annotations
V	UTIL	UKWN	WALL		7	Continuous	Unknown Utility Line Walls
V	UTIL	WAHP			5	Water	High Pressure Water Lines
V	UTIL	WAHP	SYMB		5	Continuous	High Pressure Water Line Symbols
V	UTIL	WAHP	TEXT		7	Continuous	High Pressure Water Line Annotations
V	UTIL	WAIR			5	Water	Irrigation Pressure Water Lines
V	UTIL	WAIR	SYMB		5	Continuous	Irrigation Pressure Water Line Symbols
V	UTIL	WAIR	TEXT		7	Continuous	Irrigation Pressure Water Line Annotations
V	UTIL	WALP			5	Water	Low Pressure Water Lines
V	UTIL	WALP	SYMB		5	Continuous	Low Pressure Water Line Symbols
V	UTIL	WALP	TEXT		7	Continuous	Low Pressure Water Line Annotations
V	UTIL	WAMP			5	Water	Medium Pressure Water Lines
V	UTIL	WAMP	SYMB		5	Continuous	Medium Pressure Water Line Symbols
V	UTIL	WAMP	TEXT		7	Continuous	Medium Pressure Water Line Annotations
V	UTIL	WATR			5	Water	Domestic Water Lines
V	UTIL	WATR	PATT		5	Continuous	Domestic Water Line Pattern
V	UTIL	WATR	SYMB		5	Continuous	Domestic Water Line Symbols
V	UTIL	WATR	TEXT		7	Continuous	Domestic Water Line Annotations
V	UTIL	WATR	WALL		5	Continuous	Domestic Water Line Walls

1.11.16 POINTS

Discipline	Major	Minor	Desc	Phase	Color	Linetype	Description
V	PNTS	OS			8	Continuous	Out of Service Points
V	PNTS	ABAN			7	Continuous	Abandoned Points

V	PNTS	BLDG			13	Continuous	Building Points
V	PNTS	CTRL			8	Continuous	Control Points
V	PNTS	ENVR	BORE		7	Continuous	Borehole Points
V	PNTS	ENVR	MISC		7	Continuous	Miscellaneous Environmental Points
V	PNTS	ENVR	MONW		7	Continuous	Monitoring Wall Points
V	PNTS	ENVR	SETP		7	Continuous	Settling Points
V	PNTS	ENVR	WETL		5	Continuous	Wetlands Points
V	PNTS	GNRL			7	Continuous	General Points
V	PNTS	HYPS			8	Continuous	Hypsography Points
V	PNTS	MARK			8	Continuous	Pavement Marking Points
V	PNTS	PAVE			8	Continuous	Pavement Points
V	PNTS	RLRD	BBAL		8	Continuous	Bottom of Ballast Points
V	PNTS	RLRD	ELEC		1	Continuous	Railroad Electrical Points
V	PNTS	RLRD	MISC		1	Continuous	Miscellaneous Railroad Points
V	PNTS	RLRD	POWR		8	Continuous	Railroad Power Points
V	PNTS	RLRD	PTOF		1	Continuous	Point of Frog Points
V	PNTS	RLRD	PTOS		1	Continuous	Point of Switch Points
V	PNTS	RLRD	TBAL		8	Continuous	Top of Ballast Points
V	PNTS	RLRD	TRCK		8	Continuous	Railroad Track Points
V	PNTS	SIGN			31	Continuous	Signage Points
V	PNTS	SITE			7	Continuous	Site Points
V	PNTS	SITE	FENC		7	Continuous	Fence Points
V	PNTS	SITE	GRID		8	Continuous	Site Grid Points
V	PNTS	SITE	MISC		8	Continuous	Miscellaneous Site Work Points
V	PNTS	SITE	MRSH		5	Continuous	Marsh Points
V	PNTS	SITE	VEGE		80	Continuous	Vegetation Points
V	PNTS	SITE	WALL		8	Continuous	Wall Points
V	PNTS	TEXT			8	Continuous	Text Identification of Points
V	PNTS	UTIL			7	Continuous	Utility Points
V	PNTS	UTIL	AIRL		5	Continuous	Air Line Utility Points
V	PNTS	UTIL	CFAA		8	Continuous	FAA Utility Points
V	PNTS	UTIL	CFIR		8	Continuous	Fire Utility Points
V	PNTS	UTIL	CFOC		8	Continuous	Fiber Optic Cable Utility Points
V	PNTS	UTIL	CHIL		5	Continuous	Chilled Water Utility Points
V	PNTS	UTIL	COMB		80	Continuous	Combined Utility Points
V	PNTS	UTIL	COMM		31	Continuous	Communication Utility Points
V	PNTS	UTIL	CSEC		8	Continuous	Security Utility Points
V	PNTS	UTIL	CTEL		8	Continuous	Telephone Utility Points
V	PNTS	UTIL	CTLV		8	Continuous	Closed Circuit Television Utility Points
V	PNTS	UTIL	CTRF		8	Continuous	Traffic Utility Points
V	PNTS	UTIL	DRAN		80	Continuous	Drainage Utility Points
V	PNTS	UTIL	ELCP		8	Continuous	Cathodic Protection Utility Points
V	PNTS	UTIL	ELEC		1	Continuous	Electric Utility Points
V	PNTS	UTIL	FLDI		8	Continuous	Diesel Utility Points
V	PNTS	UTIL	FLGS		8	Continuous	Gasoline Utility Points
V	PNTS	UTIL	FLPG		8	Continuous	Propane Gas Utility Points
V	PNTS	UTIL	FOAM		5	Continuous	Foam Utility Points
V	PNTS	UTIL	FUEL		61	Continuous	Fuel Utility Points
V	PNTS	UTIL	NGAS		2	Continuous	Natural Gas Utility Points
V	PNTS	UTIL	POLE		7	Continuous	Utility Pole Points
V	PNTS	UTIL	SSWR		84	Continuous	Sanitary Sewer Utility Points
V	PNTS	UTIL	STEM		7	Continuous	Steam Utility Points
V	PNTS	UTIL	TDSL		5	Continuous	Thermal Distribution System Utility Points
V	PNTS	UTIL	UKWN		7	Continuous	Unknown Utility Points
V	PNTS	UTIL	WATR		5	Continuous	Water Utility Points

1.12 APPENDIX B - FIELD DESCRIPTION CODE

Out of Service Codes	Description	Point Layer	Symbol
OSFP*	OUT OF SERVICE FENCE POST	V-PNTS-__OS	OSFP
OSGDP*	OUT OF SERVICE GUIDE POST	V-PNTS-__OS	OSGDP

OSTLT*	OUT OF SERVICE TAXI-WAY LIGHT	V-PNTS-__OS	OSTWLT
OSTWLT*	OUT OF SERVICE TAXI-WAY EDGE LIGHT	V-PNTS-__OS	OSTWEDLT
Building Codes	Description	Point Layer	Symbol
BLD*	BUILDING OUTLINE	V-PNTS-BLDG	N/A
BTUN*	BOTTOM OF TUNNEL	V-PNTS-BLDG	N/A
COL*	COLUMN	V-PNTS-BLDG	COL
DET*	ROOF DETAILS	V-PNTS-BLDG	N/A
MTRHS*	METER HOUSE	V-PNTS-BLDG	MTRHS
PAT*	PATIO	V-PNTS-BLDG	N/A
POOL*	SWIMMING POOLS	V-PNTS-BLDG	N/A
RF*	BUILDING ROOF LINE	V-PNTS-BLDG	N/A
ROOF*	ROOF LINE	V-PNTS-BLDG	N/A
SHED*	SHED	V-PNTS-BLDG	N/A
STR*	STAIRS	V-PNTS-BLDG	N/A
SUB*	SUBSTRUCTURES	V-PNTS-BLDG	N/A
TUN*	TUNNEL	V-PNTS-BLDG	N/A
Control Codes	Description	Point Layer	Symbol
AHCP*	AERIAL HORIZONTAL POINT	V-PNTS-CTRL	AHCP
AVCP*	AERIAL VERTICAL POINT	V-PNTS-CTRL	AVCP
GR27E*	CNTRL GRID NYE NAD27	V-PNTS-CTRL	N/A
GR27J*	CNTRL GRID NJ NAD27	V-PNTS-CTRL	N/A
GR83E*	CNTRL GRID NYE NAD83	V-PNTS-CTRL	N/A
GR83J*	CNTRL GRID NJ NAD83	V-PNTS-CTRL	N/A
GR83LI*	CNTRL GRID LI NAD83	V-PNTS-CTRL	N/A
GRBOG*	CNTRL GRID BOGART	V-PNTS-CTRL	N/A
GRMCH*	CNTRL GRID MEM. CHURCH	V-PNTS-CTRL	N/A
GRNDT*	CNTRL GRID NO DATUM	V-PNTS-CTRL	N/A
GRQNS*	CNTRL GRID QUEENS	V-PNTS-CTRL	N/A
HCP*	HORIZONTAL CONTROL POINT	V-PNTS-CTRL	HCP
HVCP*	HORIZ. AND VERT. CONTROL POINT	V-PNTS-CTRL	HVCP
VCP*	VERTICAL CONTROL POINT	V-PNTS-CTRL	VCP
Environmental Codes	Description	Point Layer	Symbol
BH*	BORE HOLE	V-PNTS-ENVR-BORE	BH
EHZ*	EDGE OF HAZARD	V-PNTS-ENVR-HAZR	N/A
EXW*	EXTRACTION WELL	V-PNTS-ENVR-MISC	EXW
HDP*	HYDROPUNCH	V-PNTS-ENVR-MISC	HDP
LCB*	LEACHING BASIN	V-PNTS-ENVR-MISC	LCB
MWL*	MONITORING WELL	V-PNTS-ENVR-MONW	MW

PHR*	EDGE OF PHRAGMITES	V-PNTS-ENVR-PHRG	N/A
SPT*	SETTLING POINT	V-PNTS-ENVR-SETP	SPT
WFL*	WETLAND FLAG	V-PNTS-ENVR-WETL	WFL
Hypsography Codes	Description	Point Layer	Symbol
BS*	BOTTOM OF SLOPE OR BANK	V-PNTS-HYPS	N/A
DEP-INDEX*	DEPRESSION INDEX CONTOUR	V-PNTS-HYPS	N/A
DEP-INTER*	DEPRESSION INTERMEDIATE CONTOUR	V-PNTS-HYPS	N/A
D-O-INDEX*	D-O INDEX CONTOUR	V-PNTS-HYPS	N/A
D-O-INTER*	D-O INTERMEDIATE CONTOUR	V-PNTS-HYPS	N/A
DTM*	DIGITAL TERRAIN MODEL	V-PNTS-HYPS	DTM
INDEX*	INDEX CONTOUR	V-PNTS-HYPS	N/A
INTER*	INTERMEDIATE CONTOUR	V-PNTS-HYPS	N/A
OBS-INDEX*	OBS INDEX CONTOUR	V-PNTS-HYPS	N/A
OBS-INTER*	OBS INTERMEDIATE CONTOUR	V-PNTS-HYPS	N/A
SSHT*	SPOT SHOT	V-PNTS-HYPS	SSHT
TS*	TOP OF SLOPE OR BANK	V-PNTS-HYPS	N/A
Legal Codes	Description	Point Layer	Symbol
EBH*	BULKHEAD	V-PNTS-LEGL	N/A
EPH*	PIERHEAD	V-PNTS-LEGL	N/A
LBLK*	BULKHCSG LINE	V-PNTS-LEGL	N/A
LEAS*	EASMENT LINES	V-PNTS-LEGL	N/A
LL*	LEASE LINES	V-PNTS-LEGL	N/A
LPRH*	PIERHEAD LINE	V-PNTS-LEGL	N/A
PL*	PROPERTY LINES	V-PNTS-LEGL	N/A
TL*	TENENT LINES	V-PNTS-LEGL	N/A
Pavement Marking Codes	Description	Point Layer	Symbol
APPM*	APRON PAVEMENT MARKINGS	V-PNTS-MARK	N/A
ARAL*	90D ARROW LEFT	V-PNTS-MARK	TD-6009L
ARAR*	90D ARROW RIGHT	V-PNTS-MARK	TD-6009R
ARBL*	30D ARROW LEFT	V-PNTS-MARK	TD-6011L
ARBR*	30D ARROW RIGHT	V-PNTS-MARK	TD-6011R
ARCL*	TWO ARROWS LEFT	V-PNTS-MARK	TD-6010L
ARCR*	TWO ARROWS RIGHT	V-PNTS-MARK	TD-6010R
ARDP*	ARROWS STRAIGHT AND RIGHT	V-PNTS-MARK	TD-6012
ARE*	ARROWS STRAIGHT AND LEFT	V-PNTS-MARK	TD-6017
ARF*	SINGLE ARROW	V-PNTS-MARK	TD-6013
ARG*	DIVIDED ARROWS	V-PNTS-MARK	TD-6014
ARO*	TEXT ON "ONLY"	V-PNTS-MARK	TD-6016

ARS*	TEXT ON "STOP"	V-PNTS-MARK	TD-6015
BWL*	BROKEN WHITE LANE LINE	V-PNTS-MARK	N/A
BYLP*	BROKEN YELLOW LANE LINE PARK	V-PNTS-MARK	N/A
BYLR*	BROKEN YELLOW LANE LINE ROAD	V-PNTS-MARK	N/A
CW*	CROSSWALK LINE	V-PNTS-MARK	N/A
DWBL*	DOUBLE WHITE BAR. LINE	V-PNTS-MARK	N/A
DWL*	DOTTED WHITE LANE LINE	V-PNTS-MARK	N/A
DYBL*	DOUBLE YELLOW BAR. LINE	V-PNTS-MARK	N/A
DYL*	DOTTED YELLOW LANE LINE	V-PNTS-MARK	N/A
FWBL*	FULL WHITE BAR. LINE	V-PNTS-MARK	N/A
FYBL*	FULL YELLOW BAR. LINE	V-PNTS-MARK	N/A
HANDI*	HANDICAP SYMBOL PARK	V-PNTS-MARK	HANDI
HSTAL*	PARKING HANDICAPPED STALL	V-PNTS-MARK	N/A
PWB*	PARTIAL WHITE BAR. LINE	V-PNTS-MARK	N/A
PYB*	PARTIAL YELLOW BAR. LINE	V-PNTS-MARK	N/A
RCL*	RUNWAY CENTERLINE	V-PNTS-MARK	N/A
REL*	RUNWAY EDGE LINE	V-PNTS-MARK	N/A
RMM*	RUNWAY MISC MARKINGS	V-PNTS-MARK	N/A
STAL*	PARKING STALL	V-PNTS-MARK	N/A
STOP*	STOP LINE	V-PNTS-MARK	N/A
SWCHL*	SOLID WHITE CHANNEL LINE	V-PNTS-MARK	N/A
SWEL*	SOLID WHITE EDGE LINE	V-PNTS-MARK	N/A
SWLL*	SOLID WHITE LANE LINE	V-PNTS-MARK	N/A
SYCHL*	SOLID YELLOW CHANNEL LINE	V-PNTS-MARK	N/A
SYEL*	SOLID YELLOW EDGE LINE	V-PNTS-MARK	N/A
SYL*	SOLID YELLOW LANE LINE	V-PNTS-MARK	N/A
TCL*	TAXIWAY CENTERLINE	V-PNTS-MARK	N/A
TDEL*	TAXIWAY DASHED EDGE LINE	V-PNTS-MARK	N/A
TSEL*	TAXIWAY SOLID EDGE LINE	V-PNTS-MARK	N/A
Pavement Codes	Description	Point Layer	Symbol
AJT*	ASPHALT JOINT	V-PNTS-PAVE	N/A
BC*	BOTTOM OF CURB	V-PNTS-PAVE	N/A
CBUMP*	CONCRETE BUMPER	V-PNTS-PAVE	CBUMP
CRK*	CRACK	V-PNTS-PAVE	N/A
DC*	DROP CURB	V-PNTS-PAVE	N/A
DEL*	DELINEATOR	V-PNTS-PAVE	DEL
EA*	EDGE OF ASPHALT	V-PNTS-PAVE	N/A
EBR*	BRIDGE CONCRETE	V-PNTS-PAVE	N/A
EGU*	EDGE OF GUTTER	V-PNTS-PAVE	N/A

ESB*	BRIDGE STEEL	V-PNTS-PAVE	N/A
EP*	EDGE OF PAVEMENT	V-PNTS-PAVE	N/A
HRR*	HANDICAP RAMP	V-PNTS-PAVE	HR
IMPA*	IMPACT ATTENUATOR	V-PNTS-PAVE	N/A
JB*	JERSEY or CONCRETE BAR.	V-PNTS-PAVE	N/A
JT*	EXPANSION JOINT	V-PNTS-PAVE	N/A
QC*	QUICK CURB	V-PNTS-PAVE	N/A
RAMP*	RAMP	V-PNTS-PAVE	N/A
RD.NAME*	ROAD NAMES	V-PNTS-PAVE	N/A
REF*	REFLECTOR	V-PNTS-PAVE	REF
RHA*	RUNWAY HOLDING AREA	V-PNTS-PAVE	N/A
SDB*	SPEED BUMP	V-PNTS-PAVE	N/A
TC*	TOP OF CURB	V-PNTS-PAVE	N/A
TG*	SUPER DUCT - TRAFFIC GUIDE	V-PNTS-PAVE	N/A
THP*	TAXIWAY HOLDING POSITION	V-PNTS-PAVE	N/A
TRAIL*	CENTERLINE OF TRAIL	V-PNTS-PAVE	N/A
WPA*	EDGE OF WALK PAVERS	V-PNTS-PAVE	N/A
Railroad Codes	Description	Point Layer	Symbol
BB*	BOTTOM OF BALLAST	V-PNTS-RLRD-BBAL	N/A
BXTR*	TRIP BOX	V-PNTS-RLRD-ELEC	BXTR
PF*	POINT OF FROG	V-PNTS-RLRD-PTOF	POF
PS*	POINT OF SWITCH	V-PNTS-RLRD-PTOS	POS
RAS*	AUTOMATIC SIGNAL	V-PNTS-RLRD-MISC	RAS
RBB*	BUMPING BLOCK	V-PNTS-RLRD-MISC	RBB
RBR*	RUBBER	V-PNTS-RLRD-MISC	N/A
RCG*	CROSSING GATE	V-PNTS-RLRD-MISC	RCG
RCT*	CONTROL TOWER	V-PNTS-RLRD-MISC	RCT
REI*	EMP PICKUP INDICATOR	V-PNTS-RLRD-MISC	REI
REP*	EMP PICKUP PLAT	V-PNTS-RLRD-MISC	REP
RIMP*	IMPEDENCE BOND	V-PNTS-RLRD-MISC	RIMP
RIS*	INTERLOCKING SIGNAL	V-PNTS-RLRD-MISC	RIS
RPR*	RAILROAD POWER RAIL	V-PNTS-RLRD-POWR	N/A
RPS*	STOP POWER RAIL	V-PNTS-RLRD-MISC	RPS
RQR*	ROUTE REQUEST	V-PNTS-RLRD-MISC	RQR
RR*	TRACK CENTERLINE	V-PNTS-RLRD-CLIN	N/A
RSB*	SMASHBOARD	V-PNTS-RLRD-MISC	RSB
RST*	STOP ON TRACK	V-PNTS-RLRD-MISC	N/A
RTI*	TRACK INDICATOR	V-PNTS-RLRD-MISC	RTI
SB*	SWITCH BOX	V-PNTS-RLRD-MISC	SB
TB*	TOP OF BALLAST	V-PNTS-RLRD-TBAL	N/A

TRACK*	RAILROAD TRACK LINE	V-PNTS-RLRD-TRCK	N/A
Signage Codes	Description	Point Layer	Symbol
GDS*	SIGN GUIDE	V-PNTS-SIGN	SN
INF*	SIGN INFO	V-PNTS-SIGN	SN
OSSN*	OUT OF SERVICE SIGN POST	V-PNTS-SIGN	SN
REG*	SIGN REGULATORY	V-PNTS-SIGN	SN
RWSN*	SIGN RUNWAY	V-PNTS-SIGN	RWSN
SN*	SIGN GENERAL	V-PNTS-SIGN	SN
SNOB*	SIGN OBJECT MARKER	V-PNTS-SIGN	SN
SNP*	SIGN POST	V-PNTS-SIGN	SNP
VMS*	SIGN VMS	V-PNTS-SIGN	VMS
WAR*	SIGN WARNING	V-PNTS-SIGN	SN
Sitework Codes	Description	Point Layer	Symbol
ABT*	ABUTMENT	V-PNTS-SITE-WALL	N/A
AF*	ATHLETIC FIELD	V-PNTS-SITE-MISC	N/A
ANT*	ANTENNA	V-PNTS-SITE-MISC	ANT
BF*	BLAST FENCE	V-PNTS-SITE-FENC	N/A
BNCH*	PARK BENCH	V-PNTS-SITE-MISC	BNCH
BOL*	BOLLARD	V-PNTS-SITE-MISC	BOL
BRLS*	SAND FILLED BARREL	V-PNTS-SITE-MISC	BRLS
BRMP*	BOAT RAMP	V-PNTS-SITE-WALL	N/A
BUC*	CONIFEROUS BUSH	V-PNTS-SITE-VEGE	BUC
BUD*	DECIDUOUS BUSH	V-PNTS-SITE-VEGE	BUD
BUOY*	BUOY	V-PNTS-SITE-MISC	BUOY
BUU*	UNKNOWN BUSH	V-PNTS-SITE-VEGE	BUU
BXS*	STEEL BOX	V-PNTS-SITE-MISC	BXS
BXSC*	BOX W/ STEEL COVER	V-PNTS-SITE-MISC	BXSC
BXTI*	TICKET DISPENSER	V-PNTS-SITE	TICDIS
CLT*	CLEAT	V-PNTS-SITE-MISC	CLT
CNT*	CONTAINER	V-PNTS-SITE-MISC	N/A
CPAD*	CONCRETE PAD	V-PNTS-SITE-MISC	N/A
CUL*	CULVERT	V-PNTS-SITE-MISC	N/A
DAM*	DAM or DIKE	V-PNTS-SITE-MISC	N/A
DK*	DECK	V-PNTS-SITE-MISC	N/A
DOL*	DOLPHIN	V-PNTS-SITE-MISC	DOL
EC*	EDGE OF CONCRETE	V-PNTS-SITE-MISC	N/A
ED*	EDGE OF DIRT	V-PNTS-SITE-MISC	N/A
EGR*	EDGE OF GRAVEL	V-PNTS-SITE-MISC	N/A
EOST*	EDGE OF STONE	V-PNTS-SITE-MISC	N/A
ERRP*	EDGE OF RIPRAP	V-PNTS-SITE-MISC	N/A

ESR*	EDGE OF STEEL	V-PNTS-SITE-MISC	N/A
EWA*	EDGE OF WATER	V-PNTS-SITE-WATR	N/A
EWf*	WHARF	V-PNTS-SITE-WATR	N/A
FEND*	FENDER	V-PNTS-SITE-MISC	FEND
FL*	FENCE LINE	V-PNTS-SITE-FENC	N/A
FLP*	FLAGPOLE	V-PNTS-SITE-MISC	XFP
FP*	FENCE POST	V-PNTS-SITE-FENC	FP
GDP*	GUARD POST	V-PNTS-SITE-FENC	GDP
GDRB*	GUIDE RAIL BOX BEAM	V-PNTS-SITE-FENC	N/A
GDRT*	GUIDE RAIL THRIE BEAM	V-PNTS-SITE-FENC	N/A
GDRW*	GUIDE RAIL W BEAM	V-PNTS-SITE-FENC	N/A
GP*	GATE POST	V-PNTS-SITE-FENC	GP
GRA*	GRID SHOT ASPHALT	V-PNTS-SITE-GRID	N/A
GRC*	GRID SHOT CONCRETE	V-PNTS-SITE-GRID	N/A
GRDR*	GUIDE RAIL	V-PNTS-SITE-FENC	N/A
GRGRS*	GRID SHOT GRASS	V-PNTS-SITE-GRID	N/A
GRGRV*	GRID SHOT GRAVEL	V-PNTS-SITE-GRID	N/A
HDR*	HAND RAIL	V-PNTS-SITE-FENC	HDR
HEG*	HEDGE	V-PNTS-SITE-VEGE	N/A
MAIL*	MAILBOX	V-PNTS-SITE-MISC	MB
MARSH*	MARSH or SWAMP	V-PNTS-SITE-MRSH	MARSH
MIP*	MILE POST	V-PNTS-SITE-MISC	MIP
MRSHLN*	MARSH or SWAMP LINE	V-PNTS-SITE-MRSH	N/A
PILE*	PILE	V-PNTS-SITE-MISC	PILE
PKGT*	PARKING GATE	V-PNTS-SITE-MISC	PKGT
PM*	PARKING METER	V-PNTS-SITE-MISC	PM
POPIT*	PUMP OUT PIT	V-PNTS-SITE	POPIT
POST*	POST	V-PNTS-SITE-MISC	POST
PREG*	PRES. REGULATOR	V-PNTS-SITE	PREG
PTR*	PLANTER ROUND	V-PNTS-SITE-MISC	PTR
PTS*	PLANTER SQUARE	V-PNTS-SITE-MISC	PTS
ROCK*	ROCK OUTCROP	V-PNTS-SITE-MISC	N/A
SD*	SATELLITE DISH	V-PNTS-SITE-MISC	SD
STAT*	STATUE or MONUMENT	V-PNTS-SITE-MISC	STAT
STMP*	STUMP	V-PNTS-SITE-VEGE	STMP
SWAL*	STONE WALL	V-PNTS-SITE-WALL	N/A
TDN*	TIE DOWN	V-PNTS-SITE-MISC	TDN
TRC*	CONIFEROUS TREE	V-PNTS-SITE-VEGE	TRC
TRD*	DECIDUOS TREE	V-PNTS-SITE-VEGE	TRD
TRE*	TREE LINE	V-PNTS-SITE-VEGE	N/A

TRL*	TRAILER	V-PNTS-SITE-MISC	N/A
TWR*	TOWER	V-PNTS-SITE-MISC	TWR
VENT*	VENT	V-PNTS-SITE-MISC	VENT
VP*	VENT PIPE	V-PNTS-SITE-MISC	VENT
WALB*	BOTTOM RET WALL	V-PNTS-SITE-WALL	N/A
WALL*	GENERAL WALL	V-PNTS-SITE-WALL	N/A
WALT*	TOP OF RET WALL	V-PNTS-SITE-WALL	N/A
WF*	WATER FOUNTAIN	V-PNTS-SITE-MISC	WF
WS*	WINDSOCK	V-PNTS-SITE-MISC	WS
Misc. Utility Codes	Description	Point Layer	Symbol
ENDC*	END CAP	V-PNTS-UTIL	END_CAP
ENDP*	END PLUG	V-PNTS-UTIL	END_PLUG
INV*	INVERT	V-PNTS-UTIL	N/A
PSTA*	PUMP STATION	V-PNTS-UTIL	PMPSTA
REDUC*	REDUCER	V-PNTS-UTIL	REDUC
SC*	STEEL COVER	V-PNTS-UTIL	N/A
TMKR*	TEMPORARY MARKER	V-PNTS-UTIL	TMKR
WPO*	WOOD UTILITY POLE	V-PNTS-UTIL-POLE	WPO
WYE*	WYE	V-PNTS-UTIL	N/A
Air Utility Codes	Description	Point Layer	Symbol
AIR*	AIR LINE	V-PNTS-UTIL-AIRL	N/A
MHA*	AIR MH	V-PNTS-UTIL-AIRL	MHA
UGA*	MARKED OUT AIR LINE	V-PNTS-UTIL-AIRL	N/A
UGMA*	UNDER GROUND PIPE MARKER AIR	V-PNTS-UTIL-AIRL	UGMA
Chilled Water Utility Codes	Description	Point Layer	Symbol
CHW*	CHILLED WATER LINE	V-PNTS-UTIL-CHIL	N/A
CWV*	CHILLED WATER VALVE	V-PNTS-UTIL-CHIL	CWV
FCC*	FILLER CAP CHILLED WATER	V-PNTS-UTIL-CHIL	FCC
MHCW*	CHILLED WATER MH	V-PNTS-UTIL-CHIL	MHW
UGCHW*	MARKED OUT CHILLED WATER LINE	V-PNTS-UTIL-CHIL	N/A
Combined Utility Codes	Description	Point Layer	Symbol
CBC*	SINGLE CB COMBINED	V-PNTS-UTIL-COMB	CB
CBDC*	DOUBLE CB COMBINED	V-PNTS-UTIL-COMB	CBD
CBRC*	ROUND CB COMBINED	V-PNTS-UTIL-COMB	CBR
CBSC*	SQUARE CB COMBINED	V-PNTS-UTIL-COMB	CBS
COC*	CLEANOUT COMBINED	V-PNTS-UTIL-COMB	CO
COMB*	COMBINED SANITARY & DRAN LINE	V-PNTS-UTIL-COMB	N/A

MHCMB*	COMBINED SANITARY & DRANAGE MH	V-PNTS-UTIL-COMB	MHSS
UGCMB*	MARKED OUT COMBINED SANITARY & DRAN LINE	V-PNTS-UTIL-COMB	N/A
Misc. Communication Utility Codes	Description	Point Layer	Symbol
BXC*	COMMUNICATION BOX	V-PNTS-UTIL-COMM	BXC
COMM*	GENERAL COMMUNICATION LINE	V-PNTS-UTIL-COMM	N/A
CRSR*	COMMUNICATION RISER	V-PNTS-UTIL-COMM	CRSR
ECC*	EDGE OF CONCRETE COMMUNICATION DUCT BANK	V-PNTS-UTIL-COMM	N/A
GW*	GUY WIRE POST	V-PNTS-UTIL-COMM	GW
HHC*	HAND HOLE COMMUNICATION	V-PNTS-UTIL-COMM	HHC
MHC*	GENERAL COMMUNICATION MH	V-PNTS-UTIL-COMM	MHC
UGC*	MARKED OUT COMMUNICATIONS LINE	V-PNTS-UTIL-COMM	N/A
FAA Utility Codes	Description	Point Layer	Symbol
FAA*	COMMUNICATION LINE FAA	V-PNTS-UTIL-COMM	N/A
MHFAA*	COMMUNICATION FAA MH	V-PNTS-UTIL-COMM	MHFAA
UGFAA*	MARKED OUT COMMUNICATION FAA LINE	V-PNTS-UTIL-COMM	N/A
UGMFAA*	UNDER GROUND PIPE MARKER COMMUNICATION FAA	V-PNTS-UTIL-COMM	UGMFI
Fire Utility Codes	Description	Point Layer	Symbol
BXF*	FIRE PULL BOX	V-PNTS-UTIL-COMM	BXF
FIRE*	COMMUNICATION LINE FIRE	V-PNTS-UTIL-COMM	N/A
MHFIRE*	COMMUNICATION FIRE MH	V-PNTS-UTIL-COMM	MHFI
UGFI*	MARKED OUT COMMUNICATION FIRE LINE	V-PNTS-UTIL-COMM	N/A
UGMFI*	UNDER GROUND PIPE MARKER COMMUNICATION FIRE	V-PNTS-UTIL-COMM	UGMFI
WPF*	WOOD POLE W/ FIRE BOX	V-PNTS-UTIL-COMM	WPF
Fiber Optic Utility Codes	Description	Point Layer	Symbol
FOC*	FIBER OPTIC CABLE	V-PNTS-UTIL-COMM	N/A
UGFOC*	MARKED OUT COMMUNICATION FIBER OPTIC LINE	V-PNTS-UTIL-COMM	N/A
UGMFOC*	UNDER GROUND PIPE MARKER COMMUNICATION FIBER OPTIC	V-PNTS-UTIL-COMM	UGMFO
Security Utility Codes	Description	Point Layer	Symbol
MHSEC*	COMMUNICATION MH SECURITY	V-PNTS-UTIL-COMM	MHSC
SEC*	COMMUNICATION LINE SECURITY	V-PNTS-UTIL-COMM	N/A
UGMSC*	UNDER GROUND PIPE MARKER COMMUNICATIONS SECURITY	V-PNTS-UTIL-COMM	UGMC

UGSE*	MARKED OUT COMMUNICATION SECURITY LINE	V-PNTS-UTIL-COMM	N/A
Telephone Utility Codes	Description	Point Layer	Symbol
BXT*	TELEPHONE BOX	V-PNTS-UTIL-COMM	BXT
MHT*	COMMUNICATION MH TELEPHONE	V-PNTS-UTIL-COMM	MHT
PB*	PHONE BOOTH	V-PNTS-UTIL-COMM	PB
PP*	PHONE POST	V-PNTS-UTIL-COMM	PP
TEL*	COMMUNICATION LINE TELEPHONE	V-PNTS-UTIL-COMM	N/A
UGMTE*	UNDER GROUND PIPE MARKER TELEPHONE	V-PNTS-UTIL-COMM	UGMTE
UGTE*	MARKED OUT TELEPHONE LINE	V-PNTS-UTIL-COMM	N/A
Traffic Utility Codes	Description	Point Layer	Symbol
BXTC*	TRAFFIC SIGNAL BOX	V-PNTS-UTIL-COMM	BXTC
MHTC*	COMMUNICATION MH TRAFFIC	V-PNTS-UTIL-COMM	MHTC
MTL*	METAL TRAFFIC SIGNAL	V-PNTS-UTIL-COMM	MTL
SPLBX*	SPLICE BOX	V-PNTS-UTIL-COMM	SPLBX
TOLB*	TOLL BOOTH	V-PNTS-UTIL-COMM	N/A
TRAF*	COMMUNICATION TRAFFIC LINE	V-PNTS-UTIL-COMM	N/A
TRFS*	TRAFFIC SENSOR	V-PNTS-UTIL-COMM	TRFS
UGMTR*	UNDER GROUND PIPE MARKER TRAFFIC	V-PNTS-UTIL-COMM	UGMTR
UGTR*	MARKED OUT TRAFFIC LINE	V-PNTS-UTIL-COMM	N/A
WPT*	WOOD POLE W/ TRAFFIC SIGNAL	V-PNTS-UTIL-COMM	WPT
WTL*	TRAFFIC SIGNAL POLE	V-PNTS-UTIL-COMM	WTL
Television Utility Codes	Description	Point Layer	Symbol
MHTV*	COMMUNICATION MH CABLE TV	V-PNTS-UTIL-COMM	MHTV
TV*	COMMUNICATION LINE CABLE TV	V-PNTS-UTIL-COMM	N/A
UGMC*	UNDER GROUND PIPE MARKER COMMUNICATIONS	V-PNTS-UTIL-COMM	UGMC
UGMTV*	UG MARKER CABLE TV	V-PNTS-UTIL-COMM	UGMTV
UGTV*	MARKED OUT CABLE TV	V-PNTS-UTIL-COMM	N/A
Drainage Utility Codes	Description	Point Layer	Symbol
CBD*	SINGLE CB DRAINAGE	V-PNTS-UTIL-DRAN	CB
CBDD*	DOUBLE CB DRAINAGE	V-PNTS-UTIL-DRAN	CBD
CBRD*	ROUND CB DRAINAGE	V-PNTS-UTIL-DRAN	CBR
CBSD*	SQUARE CB DRAINAGE	V-PNTS-UTIL-DRAN	CBS
COD*	CLEANOUT DRAINAGE	V-PNTS-UTIL-DRAN	CO
DISUMP*	DE-ICING SUMP	V-PNTS-UTIL-DRAN	DISUMP

DIV*	DE-ICING STORM VALVE	V-PNTS-UTIL-DRAN	DIV
DMTR*	MITERED END	V-PNTS-UTIL-DRAN	DMTR
DRAIN*	STORM DRAINAGE LINE	V-PNTS-UTIL-DRAN	N/A
DRN*	DRAIN or SCUPPER	V-PNTS-UTIL-DRAN	DRN
DRS*	DRAINAGE SUMP	V-PNTS-UTIL-DRAN	DRS
DV*	DRAINAGE VALVE	V-PNTS-UTIL-DRAN	DV
HWL*	HEADWALL	V-PNTS-UTIL-DRAN	HEADWL
MHD*	STORM DRAINAGE MH	V-PNTS-UTIL-DRAN	MHD
MHGD*	STORM DRAINAGE MH WITH SQUARE OR RECTANGLE BASE	V-PNTS-UTIL-DRAN	MHGD
OUTFALL*	OUTFALL	V-PNTS-UTIL-DRAN	OUTFALL
OWSD*	OIL WATER SEPERATOR DRAINAGE	V-PNTS-UTIL-DRAN	OWS
PSTAD*	PUMP STATION DRAINAGE	V-PNTS-UTIL-DRAN	PMPSTAD
SUMP*	STROM DRAIN SUMP	V-PNTS-UTIL-DRAN	SUMP
TDRN*	TRENCH DRAIN	V-PNTS-UTIL-DRAN	N/A
UGD*	MARKED OUT STORM DRAINAGE LINE	V-PNTS-UTIL-DRAN	N/A
UGMD*	UNDER GROUND PIPE MARKER STORM DRAINAGE	V-PNTS-UTIL-DRAN	UGMD
Electric Utility Codes	Description	Point Layer	Symbol
APLT*	APPROACH LIGHT	V-PNTS-UTIL-ELEC	APLT
BRKRHS*	BREAKER HOUSING	V-PNTS-UTIL-ELEC	BRKRHS
BXE*	ELECTRIC BOX	V-PNTS-UTIL-ELEC	BXE
BXER*	RECESSED ELECTRIC BOX	V-PNTS-UTIL-ELEC	BXER
BXP*	ELECTRIC PULL BOX	V-PNTS-UTIL-ELEC	BXP
ECE*	EDGE OF CONCRETE ELECTRIC DUCT BANK	V-PNTS-UTIL-ELEC	N/A
EGATE*	ELECTRICAL GATE	V-PNTS-UTIL-ELEC	EGATE
ELEC*	ELECTRIC LINE	V-PNTS-UTIL-ELEC	N/A
EM*	ELECTRIC METER	V-PNTS-UTIL-ELEC	EM
EMP*	ELECTRIC METER PIT	V-PNTS-UTIL-ELEC	EMP
EPNL*	ELECTRIC PANEL	V-PNTS-UTIL-ELEC	N/A
ERSR*	ELECTRIC RISER	V-PNTS-UTIL-ELEC	ERSR
GEN*	GENERATOR	V-PNTS-UTIL-ELEC	GEN
HHE*	HAND HOLE ELEC.	V-PNTS-UTIL-ELEC	HHE
LP*	PRIVATE LAMP POST	V-PNTS-UTIL-ELEC	LP
LT*	LIGHT	V-PNTS-UTIL-ELEC	LT
LTWR*	LIGHT TOWER	V-PNTS-UTIL-ELEC	LTWR
MHE*	ELECTRIC MH	V-PNTS-UTIL-ELEC	MHE
MLP*	METAL SINGLE STREET LIGHT TOWER	V-PNTS-UTIL-ELEC	MLP

MP10L*	METAL 10 LIGHT TOWER	V-PNTS-UTIL-ELEC	MP10L
MP2L*	METAL DOUBLE LIGHT TOWER	V-PNTS-UTIL-ELEC	MP2L
MP3L*	METAL TRIPLE LIGHT TOWER	V-PNTS-UTIL-ELEC	MP3L
MP4L*	METAL FOUR LIGHT TOWER	V-PNTS-UTIL-ELEC	MP4L
MPED*	METAL W/ PED LIGHT	V-PNTS-UTIL-ELEC	MPED
RWCLT*	RUNWAY CL LIGHT	V-PNTS-UTIL-ELEC	RWCLT
RWELT*	RUNWAY EDGE LIGHT	V-PNTS-UTIL-ELEC	RWELT
RWHLT*	RUNWAY HOLD LIGHT	V-PNTS-UTIL-ELEC	RWHLT
RWLT*	RUNWAY LIGHT	V-PNTS-UTIL-ELEC	RWLT
SSCC*	SURVEILANCE SYS. CNTRL CABINET	V-PNTS-UTIL-ELEC	SSCC
STG*	SUBSTA. TRNSFRMR. SWITCH GEAR	V-PNTS-UTIL-ELEC	STG
TF*	TRANSFORMER	V-PNTS-UTIL-ELEC	TF
THERMITE*	THERMITE WELD WIRE ATTACHMENT	V-PNTS-UTIL-ELEC	TRMT_WLD
THLT*	TAXIWAY HOLD LIGHT	V-PNTS-UTIL-ELEC	THLT
TSCC*	TRAFFIC SIGN CONTROL CABINET	V-PNTS-UTIL-ELEC	TSCC
TWCLT*	TAXIWAY CL LIGHT	V-PNTS-UTIL-ELEC	TWCLT
TWELT*	TAXIWAY EDGE LIGHT	V-PNTS-UTIL-ELEC	TWELT
TWLT*	TAXIWAY LIGHT	V-PNTS-UTIL-ELEC	TWLT
TWSN*	TAXIWAY SIGN	V-PNTS-UTIL-ELEC	TWSN
UGE*	MARKED OUT ELECTRIC LINE	V-PNTS-UTIL-ELEC	N/A
UGME*	UNDER GROUND PIPE MARKER ELECTRIC	V-PNTS-UTIL-ELEC	UGME
VASI*	VASI LIGHT	V-PNTS-UTIL-ELEC	VASI
VMCC*	VARIABLE MESSAGE CNTRL. CABINET	V-PNTS-UTIL-ELEC	VMCC
WLP*	WOOD POLE W/ STREET LIGHT	V-PNTS-UTIL-ELEC	WLP
WP2L*	WOOD POLE W/ 2 LIGHTS	V-PNTS-UTIL-ELEC	WP2L
Cathodic Protection Utility Codes	Description	Point Layer	Symbol
CPPDAG*	CATH. PRO. DEEP ANODE GROUNDED	V-PNTS-UTIL-ELEC	CPPDAG
CPPREH*	CATH. PRO. PERM. REF. ELECTRODE-HORZ.	V-PNTS-UTIL-ELEC	CPPREH
CPPREV*	CATH. PRO. PERM. REF. ELECTRODE-VERT.	V-PNTS-UTIL-ELEC	CPPREV
CPTS-FM*	CATH. PRO. TEST STA. FLUSH. MOUNTED	V-PNTS-UTIL-ELEC	CPTS-FM
CPTS-WM*	CATH. PRO. TEST STA. WALL. MOUNTED	V-PNTS-UTIL-ELEC	CPTS-WM
NEGRETJB*	CATH. PRO. NEGATIVE JUNCTION BOX	V-PNTS-UTIL-ELEC	NEGRETJB
POSRETJB*	CATH. PRO. POSITIVE JUNCTION BOX	V-PNTS-UTIL-ELEC	POSRETJB

RECTIFIER*	CATH. PRO. RECTIFIER	V-PNTS-UTIL-ELEC	RECTIFIER
RMU*	CATH. PRO. REMOTE MONITORING UNIT	V-PNTS-UTIL-ELEC	RMU
Foam Utility Codes	Description	Point Layer	Symbol
FMCAB*	FOAM CABINET	V-PNTS-UTIL-FOAM	FMCB
FMHSE*	FOAM HOUSING	V-PNTS-UTIL-FOAM	FMHSE
FMNOZ*	FOAM NOZZLE	V-PNTS-UTIL-FOAM	FMNOZ
FMVALV*	FOAM VALVE	V-PNTS-UTIL-FOAM	FMVALV
FOAM*	FOAM LINE	V-PNTS-UTIL-FOAM	N/A
HPWTIE*	TIE TO HIGH PRES. WATER	V-PNTS-UTIL-FOAM	HPWTIE
MHFM*	FOAM MH	V-PNTS-UTIL-FOAM	MHFM
UGFO*	MARKED OUT FOAM LINE	V-PNTS-UTIL-FOAM	N/A
UGMFM*	UNDER GROUND PIPE MARKER FOAM	V-PNTS-UTIL-FOAM	UGMFO
Fuel Utility Codes	Description	Point Layer	Symbol
BLKFLANG*	BLANK FLANG	V-PNTS-UTIL-FUEL	BLKFLANG
BRKOUT*	BREAK BETWEEN PA & NON PA	V-PNTS-UTIL-FUEL	BRKOUT
FCD*	FILLER CAP DIESEL	V-PNTS-UTIL-FUEL	FCD
FCF*	FILLER CAP FUEL	V-PNTS-UTIL-FUEL	FCF
FCG*	FILLER CAP GASOLINE	V-PNTS-UTIL-FUEL	FCG
FCJ*	FILLER CAP JETA	V-PNTS-UTIL-FUEL	FCJ
FCO*	FILLER CAP OIL	V-PNTS-UTIL-FUEL	FCO
FCP*	FILLER CAP PROPANE	V-PNTS-UTIL-FUEL	FCP
FILTSTA*	FUEL FILTRATION STATION	V-PNTS-UTIL-FUEL	FILTSTA
FIW*	FUEL INSPECTION WELL	V-PNTS-UTIL-FUEL	FIW
FUEL*	FUEL LINE	V-PNTS-UTIL-FUEL	N/A
FUI*	FUEL ISOLATION	V-PNTS-UTIL-FUEL	FUI
FUP*	FUEL PUMP	V-PNTS-UTIL-FUEL	FUP
FUPT*	FUEL LISTENING POST	V-PNTS-UTIL-FUEL	FUELPOST
FUTK*	FUEL TANK	V-PNTS-UTIL-FUEL	FUEL TANK
FUVT*	FUEL VENT	V-PNTS-UTIL-FUEL	FUVT
FV*	FUEL VALVE	V-PNTS-UTIL-FUEL	FV
FVP*	FUEL VALVE PIT	V-PNTS-UTIL-FUEL	FVP
GLV*	GASOLINE VALVE	V-PNTS-UTIL-FUEL	GLV
HYDPIT*	FUEL HYDRANT PIT	V-PNTS-UTIL-FUEL	HYDPIT
LRAKBOT*	LOADING RACK BOTTOM	V-PNTS-UTIL-FUEL	LRAKBOT
LRAKTOP*	LOADING RACK TOP	V-PNTS-UTIL-FUEL	LRAKTOP
MHFL*	FUEL MH	V-PNTS-UTIL-FUEL	MHFL
PIG*	PIG ACCESS	V-PNTS-UTIL-FUEL	PIG
PSTAF*	PUMP STATION FUEL	V-PNTS-UTIL-FUEL	PMPSTAF

TESTSTA*	TEST STATION FUEL	V-PNTS-UTIL-FUEL	TESTSTA
UGFL*	MARKED OUT FUEL LINE	V-PNTS-UTIL-FUEL	N/A
UGMFL*	UNDER GROUND PIPE MARKER FUEL	V-PNTS-UTIL-FUEL	UGMFL
VNTP*	VENT PIT	V-PNTS-UTIL-FUEL	VNTP
Natural Gas Utility Codes	Description	Point Layer	Symbol
BXG*	NATURAL GAS BOX	V-PNTS-UTIL-NGAS	BXG
CMST*	COMPRESSOR STATION	V-PNTS-UTIL-NGAS	CMST
CROSSG*	FOUR WAY NATURAL GAS TEE	V-PNTS-UTIL-NGAS	CROSS
GAS*	NATURAL GAS LINE	V-PNTS-UTIL-NGAS	N/A
GM*	NATURAL GAS METER	V-PNTS-UTIL-NGAS	GM
GRSR*	GAS RISER	V-PNTS-UTIL-NGAS	GRSR
GT*	NATURAL GAS TEST	V-PNTS-UTIL-NGAS	GT
GV*	NATURAL GAS VALVE	V-PNTS-UTIL-NGAS	GV
MHG*	NATURAL GAS MH	V-PNTS-UTIL-NGAS	MHG
TEEG*	NATURAL GAS TEE	V-PNTS-UTIL-NGAS	TEE
UGG*	MARKED OUT NATURAL GAS LINE	V-PNTS-UTIL-NGAS	N/A
UGMG*	UNDER GROUND PIPE MARKER NATURAL GAS	V-PNTS-UTIL-NGAS	UGMG
Sanitary Utility Codes	Description	Point Layer	Symbol
CO*	CLEANOUT SANITARY	V-PNTS-UTIL-SSWR	CO
MHS*	SANITARY SEWER MH	V-PNTS-UTIL-SSWR	MHS
OWSS*	OIL WATER SEPERATOR SANITARY	V-PNTS-UTIL-SSWR	OWSS
PSTAS*	PUMP STATION SANITARY	V-PNTS-UTIL-SSWR	PMPSTAS
SAN*	SANITARY SEWER LINE	V-PNTS-UTIL-SSWR	N/A
STANK*	SLUDGE TANK	V-PNTS-UTIL-SSWR	STANK
SVG*	SANITARY VALVE	V-PNTS-UTIL-SSWR	SV
UGSA*	MARKED OUT SANITARY SEWER LINE	V-PNTS-UTIL-SSWR	N/A
Steam Utility Codes	Description	Point Layer	Symbol
CROSSST*	FOUR WAY STEAM TEE	V-PNTS-UTIL-STEM	CROSS
MHST*	STEAM MH	V-PNTS-UTIL-STEM	MHST
MHSTB*	STEAM MH BURIED	V-PNTS-UTIL-STEM	MHSTB
STEAM*	STEAM LINE	V-PNTS-UTIL-STEM	N/A
STEAMA*	STEAM ANCHOR BLOCK	V-PNTS-UTIL-STEM	STEAMA
STEAMCC*	STEAM COOLING CHAMBER	V-PNTS-UTIL-STEM	STEAMCC
STEAMEJ*	STEAM EXPANSION JOINT	V-PNTS-UTIL-STEM	STEAMEJ
STEAMMG*	STEAM MOON GUIDE	V-PNTS-UTIL-STEM	STEAMMG
STEAMSJ*	STEAM SLIP JOINT	V-PNTS-UTIL-STEM	STEAMSJ

STEAMV*	STEAM VALVE	V-PNTS-UTIL-STEM	STEAMV
TEEST*	TEE STEAM	V-PNTS-UTIL-STEM	TEE
UGMST*	UNDER GROUND PIPE MARKER STEAM	V-PNTS-UTIL-STEM	UGMST
UGST*	MARKED OUT STEAM LINE	V-PNTS-UTIL-STEM	N/A
TDS Utility Codes	Description	Point Layer	Symbol
BXTDS*	THERMAL DISTRIBUTION SYSTEM BOX	V-PNTS-UTIL-TDSL	BXTDS
MHTW*	TDS WATER MH	V-PNTS-UTIL-TDSL	MHTW
TDS*	TDS WATER LINE	V-PNTS-UTIL-TDSL	N/A
TDSV*	TDS VALVE W/ STRUCTURE	V-PNTS-UTIL-TDSL	TDSV
TDSVA*	TDS VALVE W/ ACTIVATOR	V-PNTS-UTIL-TDSL	TDSVA
TDSVNS*	TDS VALVE W/OUT STRUCTURE	V-PNTS-UTIL-TDSL	TDSVNS
UGMTD*	UNDER GROUND PIPE MARKER TDS	V-PNTS-UTIL-TDSL	UGMTD
UGTD*	MARKED OUT TDS LINE	V-PNTS-UTIL-TDSL	N/A
VPTM*	TDS VALVE PIT MANHOLE	V-PNTS-UTIL-TDSL	VPTM
Unknown Utility Codes	Description	Point Layer	Symbol
BXU*	UNKNKOWN BOX	V-PNTS-UTIL-UKWN	BXU
CROSS*	FOUR WAY TEE	V-PNTS-UTIL-UKWN	CROSS
FCU*	FILLER CAP UNKNOWN	V-PNTS-UTIL-UKWN	FCU
HH*	HANDHOLE	V-PNTS-UTIL	HH
MH*	UNKNOWN UTILITY MH	V-PNTS-UTIL-UKWN	MH
MHPS*	MANHOLE PUBLIC SERVICE	V-PNTS-UTIL-UKWN	MHPS
TEE*	TEE UNKNOWN	V-PNTS-UTIL-UKWN	TEE
UUC*	UNKNOWN UTILITY CABLE	V-PNTS-UTIL-UKWN	N/A
UUP*	UNKNOWN UTILITY PIPE	V-PNTS-UTIL-UKWN	N/A
UV*	UNKNOWN VALVE	V-PNTS-UTIL-UKWN	UV
Water Utility Codes	Description	Point Layer	Symbol
BXH2O*	POTABLE WATER BOX	V-PNTS-UTIL-WATR	BXH2O
BXSP*	SPRINKLER CONTROL BOX	V-PNTS-UTIL-WATR	BXSP
CROSSW*	FOUR WAY TEE WATER	V-PNTS-UTIL-WATR	CROSS
HOTBOX*	WATER METER BOX	V-PNTS-UTIL-WATR	HOTBOX
HPTIE*	IRRIG. TIE TO HIGH PRES. WATER	V-PNTS-UTIL-WATR	HPTIE
HYD*	HYDRANT	V-PNTS-UTIL-WATR	HYD
IRCP*	IRRIGATION CONTROL PANEL	V-PNTS-UTIL-WATR	IRCP
IRV*	IRRIGATION VALVE	V-PNTS-UTIL-WATR	IRV
MHW*	WATER MH	V-PNTS-UTIL-WATR	MHW
PIV*	POST INDICATOR VALVE	V-PNTS-UTIL-WATR	PIV
SPH*	SPRINKLER HCSG	V-PNTS-UTIL-WATR	SPH

SPIGOT*	SPIGOT	V-PNTS-UTIL-WATR	SPIGOT
STP*	STAND PIPE	V-PNTS-UTIL-WATR	STP
TANK*	WATER TANK	V-PNTS-UTIL-WATR	TANK
TEEW*	WATER TEE	V-PNTS-UTIL-WATR	TEE
UGW*	MARKED OUT WATER LINE	V-PNTS-UTIL-WATR	N/A
WATER*	WATER LINE	V-PNTS-UTIL-WATR	N/A
WRSR*	WATER RISER	V-PNTS-UTIL-WATR	WRSR
WV*	WATER VALVE	V-PNTS-UTIL-WATR	WV

Note: Append "RO" to the end of any code to denote the use of reference shots.

1.13 APPENDIX C - LINETYPES

Name	Description	Example
AIR	Air Line	_____ A _____ A _____ A _____
AIR_EXSV	Air Line Existing Surveyed	_____ A--SV _____ A--SV _____ A--SV _____
AIR_EXTN	Air Line Existing Toned	_____ A--TN _____ A--TN _____ A--TN _____
AIR_EXUV	Air Line Existing Unverified	_____ A--UV _____ A--UV _____ A--UV _____
AIR_OSSV	Air Line Out Of Service Survey	_____ A--OV _____ A--OV _____ A--OV _____
AIR_OSTN	Air Line Out Of Service Toned	_____ A--OT _____ A--OT _____ A--OT _____
AIR_OSUV	Air Line Out Of Service Unverified	_____ A--OU _____ A--OU _____ A--OU _____
BBAL	Bottom Of Ballast	- - - - -
BOT	Bottom Of Slope	
CENTER	Center	_____
CHW	Chilled Water Line	_____ CHW _____ CHW _____ CHW _____
CHW_EXSV	Chilled Water Line Existing Surveyed	_____ CHW--SV _____ CHW--SV _____ CHW--SV _____
CHW_EXTN	Chilled Water Line Existing Toned	_____ CHW--TN _____ CHW--TN _____
CHW_EXUV	Chilled Water Line Existing Unverified	_____ CHW--UV _____ CHW--UV _____ CHW--UV _____
CHW_OSSV	Chilled Water Line Out Of Service Survey	_____ CHW--OV _____ CHW--OV _____ CHW--OV _____
CHW_OSTN	Chilled Water Line Out Of Service Toned	_____ CHW--OT _____ CHW--OT _____
CHW_OSUV	Chilled Water Line Out Of Service Unverified	_____ CHW--OU _____ CHW--OU _____ CHW--OU _____
COMB	Combined Drainage & Sanitary Line	_____ SS _____ SS _____ SS _____
COMB_EXSV	Combined Drainage & Sanitary Line Existing Surveyed	_____ SS--SV _____ SS--SV _____ SS--SV _____
COMB_EXTN	Combined Drainage & Sanitary Line Existing Toned	_____ SS--TN _____ SS--TN _____ SS--TN _____
COMB_EXUV	Combined Drainage & Sanitary Line Existing Unverified	_____ SS--UV _____ SS--UV _____ SS--UV _____
COMB_OSSV	Combined Drainage & Sanitary Line Out Of Service Survey	_____ SS--OV _____ SS--OV _____ SS--OV _____
COMB_OSTN	Combined Drainage & Sanitary Line Out Of Service Toned	_____ SS--OT _____ SS--OT _____ SS--OT _____
COMB_OSUV	Combined Drainage & Sanitary Line Out Of Service Unverified	_____ SS--OU _____ SS--OU _____ SS--OU _____
COMM	Communications Line	_____ C _____ C _____ C _____
COMM_EXSV	Communications Line Existing Surveyed	_____ C--SV _____ C--SV _____ C--SV _____
COMM_EXTN	Communications Line Existing Toned	_____ C--TN _____ C--TN _____ C--TN _____

Name	Description	Example
COMM_EXUV	Communications Line Existing Unverified	----- C--UV ----- C--UV ----- C--UV -----
COMM_FAA	FAA Communications Line	----- FAA ----- FAA ----- FAA -----
COMM_FAA_EXSV	FAA Communications Line Existing Surveyed	----- FAA--SV ----- FAA--SV ----- FAA--SV -----
COMM_FAA_EXTN	FAA Communications Line Existing Toned	----- FAA--TN ----- FAA--TN ----- FAA--TN -----
COMM_FAA_EXUV	FAA Communications Line Existing Unverified	----- FAA--UV ----- FAA--UV ----- FAA--UV -----
COMM_FAA_OSSV	FAA Communications Line Out Of Service Survey	----- FAA--OV ----- FAA--OV ----- FAA--OV -----
COMM_FAA_OSTN	FAA Communications Line Out Of Service Toned	----- FAA--OT ----- FAA--OT ----- FAA--OT -----
COMM_FAA_OSUV	FAA Communications Line Out Of Service Unverified	----- FAA--OU ----- FAA--OU ----- FAA--OU -----
COMM_FIRE	Fire Communication Line	----- FIRE ----- FIRE ----- FIRE -----
COMM_FIRE_EXSV	Fire Communication Line Existing Surveyed	----- FIRE--SV ----- FIRE--SV ----- FIRE--SV -----
COMM_FIRE_EXTN	Fire Communication Line Existing Toned	----- FIRE--TN ----- FIRE--TN ----- FIRE--TN -----
COMM_FIRE_EXUV	Fire Communication Line Existing Unverified	----- FIRE--UV ----- FIRE--UV ----- FIRE--UV -----
COMM_FIRE_OSSV	Fire Communication Line Out Of Service Survey	----- FIRE--OV ----- FIRE--OV ----- FIRE--OV -----
COMM_FIRE_OSTN	Fire Communication Line Out Of Service Toned	----- FIRE--OT ----- FIRE--OT ----- FIRE--OT -----
COMM_FIRE_OSUV	Fire Communication Line Out Of Service Unverified	----- FIRE--OU ----- FIRE--OU ----- FIRE--OU -----
COMM_OSSV	Communications Line Out Of Service Survey	----- C--OV ----- C--OV -----
COMM_OSTN	Communications Line Out Of Service Toned	----- C--TN ----- C--TN ----- C--TN -----
COMM_OSUV	Communications Line Out Of Service Unverified	----- C--OU ----- C--OU ----- C--OU -----
COMM_SEC	Security Communication Line	----- SEC ----- SEC ----- SEC ----- SEC
COMM_SEC_EXSV	Security Communication Line Existing Surveyed	----- SEC--SV ----- SEC--SV ----- SEC--SV ----- SEC--
COMM_SEC_EXTN	Security Communication Line Existing Toned	----- SEC--TN ----- SEC--TN ----- SEC--TN ----- SEC--T
COMM_SEC_EXUV	Security Communication Line Existing Unverified	----- SEC--UV ----- SEC--UV ----- SEC--UV ----- SEC--
COMM_SEC_OSSV	Security Communication Line Out Of Service Survey	----- SEC--OV ----- SEC--OV ----- SEC--OV -----
COMM_SEC_OSTN	Security Communication Line Out Of Service Toned	----- SEC--OT ----- SEC--OT ----- SEC--OT -----
COMM_SEC_OSUV	Security Communication Line Out Of Service Unverified	----- SEC--OU ----- SEC--OU ----- SEC--OU -----
COMM_TELE	Telephone Communication Line	----- T ----- T ----- T -----
COMM_TELE_EXSV	Telephone Communication Line Existing Surveyed	----- T--SV ----- T--SV ----- T--SV -----
COMM_TELE_EXTN	Telephone Communication Line Existing Toned	----- T--UV ----- T--UV ----- T--UV -----

Name	Description	Example
COMM_TELE_EXUV	Telephone Communication Line Existing Unverified	_____ T-0V _____ T-0V _____
COMM_TELE_OSSV	Telephone Communication Line Out Of Service Survey	_____ T-0V _____ T-0V _____
COMM_TELE_OSTN	Telephone Communication Line Out Of Service Toned	_____ T-0T _____ T-0T _____
COMM_TELE_OSUV	Telephone Communication Line Out Of Service Unverified	_____ T-0U _____ T-0U _____
COMM_TRAF	Traffic Communication Line	_____ TC _____ TC _____
COMM_TRAF_EXSV	Traffic Communication Line Existing Surveyed	_____ TC-SV _____ TC-SV _____
COMM_TRAF_EXTN	Traffic Communication Line Existing Toned	_____ TC-TN _____ TC-TN _____
COMM_TRAF_EXUV	Traffic Communication Line Existing Unverified	_____ TC-UV _____ TC-UV _____
COMM_TRAF_OSSV	Traffic Communication Line Out Of Service Survey	_____ TC-0V _____ TC-0V _____
COMM_TRAF_OSTN	Traffic Communication Line Out Of Service Toned	_____ TC-0T _____ TC-0T _____
COMM_TRAF_OSUV	Traffic Communication Line Out Of Service Unverified	_____ TC-0U _____ TC-0U _____
COMM_TV	Closed Circuit Television Line	_____ TV _____ TV _____ TV _____ TV _____
COMM_TV_EXSV	Closed Circuit Television Line Existing Surveyed	_____ TV-SV _____ TV-SV _____ TV-SV _____
COMM_TV_EXTN	Closed Circuit Television Line Existing Toned	_____ TV-TN _____ TV-TN _____ TV-TN _____
COMM_TV_EXUV	Closed Circuit Television Line Existing Unverified	_____ TV-UV _____ TV-UV _____ TV-UV _____
COMM_TV_OSSV	Closed Circuit Television Line Out Of Service Survey	— — TV-0V — — TV-0V — — TV-0V — — TV-0V —
COMM_TV_OSTN	Closed Circuit Television Line Out Of Service Toned	— — TV-0T — — TV-0T — — TV-0T — — TV-0T —
COMM_TV_OSUV	Closed Circuit Television Line Out Of Service Unverified	— — TV-0U — — TV-0U — — TV-0U — — TV-0U —
CONTINUOUS	Continuous	_____
DASHDOT	Dashdot (1x)	_____ . _____ . _____ . _____ . _____
DASHED	Dashed (1x)	_____
DASHEDX2	Dashed (2x)	_____
DIVIDE	Divide (1x)	_____
DOT2	Dot (0.5x)
DRAIN	Drainage Line	_____ D _____ D _____
DRAIN_EXSV	Drainage Line Existing Surveyed	_____ D-SV _____ D-SV _____
DRAIN_EXTN	Drainage Line Existing Toned	_____ D-TN _____ D-TN _____
DRAIN_EXUV	Drainage Line Existing Unverified	_____ D-UV _____ D-UV _____
DRAIN_OSSV	Drainage Line Out Of Service Survey	_____ E-0V _____ E-0V _____

Name	Description	Example
DRAIN_OSTN	Drainage Line Out Of Service Toned	----- D--OU -----
DRAIN_OSUV	Drainage Line Out Of Service Unverified	----- D--OU -----
DSL	DSL Line	----- DSL -----
DSL_EXSV	DSL Existing Surveyed	----- DSL--SV -----
DSL_EXTN	DSL Existing Toned	----- DSL--TN -----
DSL_EXUV	DSL Existing Unverified	----- DSL--UV -----
DSL_OSSV	DSL Out Of Service Survey	----- DSL--OV -----
DSL_OSTN	DSL Out Of Service Toned	----- DSL--OT -----
DSL_OSUV	DSL Out Of Service Unverified	----- DSL--OU -----
ELEC	Electric Line	----- E -----
ELEC_5KV	5kv Electric Line	----- 5KV -----
ELEC-5KV_EXSV	5kv Electric Line Existing Surveyed	----- 5KV--SV -----
ELEC_5KV_EXTN	5kv Electric Line Existing Toned	----- 5KV--TN -----
ELEC_5KV_EXUV	5kv Electric Line Existing Unverified	----- 5KV--UV -----
ELEC_5KV_OSSV	5kv Electric Line Out Of Service Survey	----- 5KV--OV -----
ELEC_5KV_OSTN	5kv Electric Line Out Of Service Toned	----- 5KV--OT -----
ELEC_5KV_OSUV	5kv Electric Line Out Of Service Unverified	----- 5KV--OU -----
ELEC_13_8KV	13.8kv Electric Line	----- 13.8KV -----
ELEC_13_8KV_EXSV	13.8kv Electric Line Existing Surveyed	----- 13.8KV--SV -----
ELEC_13_8KV_EXTN	13.8kv Electric Line Existing Toned	----- 13.8KV--TN -----
ELEC_13_8KV_EXUV	13.8kv Electric Line Existing Unverified	----- 13.8KV--UV -----
ELEC_13_8KV_OSSV	13.8kv Electric Line Out Of Service Survey	----- 13.8KV--OV -----
ELEC_13_8KV_OSTN	13.8kv Electric Line Out Of Service Toned	----- 13.8KV--OT -----
ELEC_13_8KV_OSUV	13.8kv Electric Line Out Of Service Unverified	----- 13.8KV--OU -----
ELEC_27KV	27kv Electric Line	----- 27KV -----
ELEC_27KV_EXSV	27kv Electric Line Existing Surveyed	----- 27KV--SV -----
ELEC_27KV_EXTN	27kv Electric Line Existing Toned	----- 27KV--TN -----
ELEC_27KV_EXUV	27kv Electric Line Existing Unverified	----- 27KV--UV -----
ELEC_27KV_OSSV	27kv Electric Line Out Of Service Survey	----- 27KV--OV -----
ELEC_27KV_OSTN	27kv ELECTRIC Line Out Of Service Toned	----- 27KV--OT -----
ELEC_27KV_OSUV	27kv Electric Line Out Of Service Unverified	----- 27KV--OU -----

Name	Description	Example
ELEC_EXSV	Electric Line Existing Surveyed	————— E-SV ————— E-SV —————
ELEC_EXTN	Electric Line Existing Toned	————— E-TN ————— E-TN —————
ELEC_EXUV	Electric Line Existing Unverified	————— E-UV ————— E-UV —————
ELEC_OSSV	Electric Line Out Of Service Survey	——— E--OV ——— E--OV ——— E--OV ———
ELEC_OSTN	Electric Line Out Of Service Toned	————— E-OU ————— E-OU —————
ELEC_OSUV	Electric Line Out Of Service Unverified	————— E-OU ————— E-OU —————
FEN	Fence	——— X —— X —— X —— X —— X ——
FOAM	Foam Line	————— FM ————— FM —————
FOAM_EXSV	Foam Line Existing Surveyed	————— FM-SV ————— FM-SV —————
FOAM_EXTN	Foam Line Existing Toned	————— FM-TN ————— FM-TN —————
FOAM_EXUV	Foam Line Existing Unverified	————— FM-UV ————— FM-UV —————
FOAM_OSSV	Foam Line Out Of Service Survey	——— FM-OV ——— FM-OV ——— FM-OV ———
FOAM_OSTN	Foam Line Out Of Service Toned	————— FM-OT ————— FM-OT —————
FOAM_OSUV	Foam Line Out Of Service Unverified	————— FM-OU ————— FM-OU —————
FOC	Fiber Optic Cable	————— FOC ————— FOC —————
FOC_EXSV	Fiber Optic Cable Existing Surveyed	————— FOC-SV ————— FOC--SV —————
FOC_EXTN	Fiber Optic Cable Existing Toned	————— FOC-TN ————— FOC-TN —————
FOC_EXUV	Fiber Optic Cable Existing Unverified	————— FOC--UV ————— FOC--UV —————
FOC_OSSV	Fiber Optic Cable Out Of Service Survey	——— FOC-OV ——— FOC-OV ——— FOC-OV ———
FOC_OSTN	Fiber Optic Cable Out Of Service Toned	————— FOC-OT ————— FOC-OT —————
FOC_OSUV	Fiber Optic Cable Out Of Service Unverified	————— FOC-OU ————— FOC-OU —————
FUEL	Fuel Line	————— F ————— F —————
FUEL_EXSV	Fuel Line Existing Surveyed	————— F-SV ————— F-SV —————
FUEL_EXTN	Fuel Line Existing Toned	————— F-TN ————— F-TN —————
FUEL_EXUV	Fuel Line Existing Unverified	————— F-UV ————— F-UV —————
FUEL_OSSV	Fuel Line Out Of Service Survey	——— F--OV ——— F--OV ——— F--OV ———
FUEL_OSTN	Fuel Line Out Of Service Toned	————— F--OT ————— F--OT —————
FUEL_OSUV	Fuel Line Out Of Service Unverified	————— F--OU ————— F--OU —————
GAS	Natural Gas Line	————— G ————— G —————
GAS_EXSV	Natural Gas Line Existing Surveyed	————— G-SV ————— G-SV —————
GAS_EXTN	Natural Gas Line Existing Toned	————— G--TN ————— G--TN —————

Name	Description	Example
GAS_EXUV	Natural Gas Line Existing Unverified	
GAS_OSSV	Natural Gas Line Out Of Service Survey	
GAS_OSTN	Natural Gas Line Out Of Service Toned	
GAS_OSUV	Natural Gas Line Out Of Service Unverified	
GSL	Gasoline Line	
GSL_EXSV	Gasoline Line Existing Surveyed	
GSL_EXTN	Gasoline Line Existing Toned	
GSL_EXUV	Gasoline Line Existing Unverified	
GSL_OSSV	Gasoline Line Out Of Service Survey	
GSL_OSTN	Gasoline Line Out Of Service Toned	
GSL_OSUV	Gasoline Line Out Of Service Unverified	
GUIDE	Guide Rail	
GUIDEB	Box Beam	
GUIDET	Thrie Beam	
GUIDEW	W Beam	
HANDRAIL	Handrail	
HEDGE	Hedge	
HIDDEN	Hidden (1x)	
HIDDENX2	Hidden (2x)	
HPW	High Pressure Water Line (1x)	
HPW	High Pressure Water Line	
HPW_EXSV	High Pressure Water Line Existing Surveyed	
HPW_EXTN	High Pressure Water Line Existing Toned	
HPW_EXUV	High Pressure Water Line Existing Unverified	
HPW_OSSV	High Pressure Water Line Out Of Service Survey	
HPW_OSTN	High Pressure Water Line Out Of Service Toned	
HPW_OSUV	High Pressure Water Line Out Of Service Unverified	
JET	Jet Fuel Line	
JET_EXSV	Jet Fuel Line Existing Surveyed	
JET_EXTN	Jet Fuel Line Existing Toned	





Name	Description	Example
JET_EXUV	Jet Fuel Line Existing Unverified	
JET_OSSV	Jet Fuel Line Out Of Service Survey	
JET_OSTN	Jet Fuel Line Out Of Service Toned	
JET_OSUV	Jet Fuel Line Out Of Service Unverified	
MPW	Medium Pressure Water Line	
MPW_EXSV	Medium Pressure Water Line Existing Surveyed	
MPW_EXTN	Medium Pressure Water Line Existing Toned	
MPW_EXUV	Medium Pressure Water Line Existing Unverified	
MPW_OSSV	Medium Pressure Water Line Out Of Service Survey	
MPW_OSTN	Medium Pressure Water Line Out Of Service Toned	
MPW_OSUV	Medium Pressure Water Line Out Of Service Unverified	
PHANTOM	Phantom (1x)	
PHANTOM2	Phantom (0.5x)	
POWER	Power Line	
PPG	Propane Gas Line	
PPG_EXSV	Propane Gas Line Existing Surveyed	
PPG_EXTN	Propane Gas Line Existing Toned	
PPG_EXUV	Propane Gas Line Existing Unverified	
PPG_OSSV	Propane Gas Line Out Of Service Survey	
PPG_OSTN	Propane Gas Line Out Of Service Toned	
PPG_OSUV	Propane Gas Line Out Of Service Unverified	
ROCK	Rock Outcrop	
RR	Railroad	
SAN	Sanitary Sewer Line (1x)	
SAN_EXSV	Sanitary Sewer Existing Surveyed	
SAN_EXTN	Sanitary Sewer Existing Toned	
SAN_EXUV	Sanitary Sewer Existing Unverified	
SAN_OSSV	Sanitary Sewer Out Of Service Survey	

Name	Description	Example
SAN_OSTN	Sanitary Sewer Out Of Service Toned	
SAN_OSUV	Sanitary Sewer Out Of Service Unverified	
STEAM	Steam Line	
STEAM_EXSV	Steam Line Existing Surveyed	
STEAM_EXTN	Steam Line Existing Toned	
STEAM_EXUV	Steam Line Existing Unverified	
STEAM_OSSV	Steam Line Out Of Service Survey	
STEAM_OSTN	Steam Line Out Of Service Toned	
STEAM_OSUV	Steam Line Out Of Service Unverified	
STREAM	Stream Line	
TBAL	Top Of Ballast	
TDS	Thermal Distribution System Line	
TDS_EXSV	TDS Existing Surveyed	
TDS_EXTN	TDS Existing Toned	
TDS_EXUV	TDS Existing Unverified	
TDS_OSSV	TDS Out Of Service Survey	
TDS_OSTN	TDS Out Of Service Toned	
TDS_OSUV	TDS Out Of Service Unverified	
TOP	Top Of Slope	
TREE	Edge Of Woods	
UNK	Unknown	
UNK_EXSV	Unknown Existing Surveyed	
UNK_EXTN	Unknown Existing Toned	
UNK_EXUV	Unknown Existing Unverified	
UNK_OSSV	Unknown Out Of Service Survey	
UNK_OSTN	Unknown Out Of Service Toned	
UNK_OSUV	Unknown Out Of Service Unverified	
WATER	Water Line	
WATER_EXSV	Water Line Existing Surveyed	
WATER_EXTN	Water Line Existing Toned	
WATER_EXUV	Water Line Existing Unverified	

Name	Description	Example
WATER_OSSV	Water Line Out Of Service Survey	————— W-0V —————
WATER_OSTN	Water Line Out Of Service Toned	————— W-0T —————
WATER_OSUV	Water Line Out Of Service Unverified	————— W-0U —————

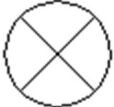
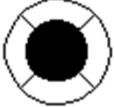
1.14 APPENDIX D – SYMBOLS BY FEATURE SET

1.14.1 FEATURE SET: OUT OF SERVICE

SYMBOL	BLOCK NAME	LAYER NAME	DESCRIPTION
	OSFP	V-SITE-FENC-POST-OSSV	Out of Service Fence Post
	OSGDP	V-SITE-FENC-MISC-OSSV	Out of Service Guide Post
	OSSN	varies	Out of Service Sign Post
	OSTWEDLT	V-UTIL-ELEC-____-OSSV	Out of Service Taxi-Way Edge Light
	OSTWLT	V-UTIL-ELEC-____-OSSV	Out of Service Taxi-Way Light

1.14.2 FEATURE SET: BUILDING

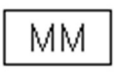

SYMBOL	BLOCK NAME	LAYER NAME	DESCRIPTION
	COL	V-BLDG-COLM-____-EXSV	Column
	MTRHS	V-BLDG-OTLN-____-EXSV	Meter House

1.14.3 FEATURE SET: CONTROL





SYMBOL	BLOCK NAME	LAYER NAME	DESCRIPTION
	AHCP	V-CTRL-PNTS-AHCP-EXSV	Aerial Horizontal Point
	AVCP	V-CTRL-PNTS-AVCP-EXSV	Aerial Vertical Point
	HCP	V-CTRL-PNTS-HSCP-EXSV	Horizontal Control Point
	HVCP	V-CTRL-PNTS-HVCP-EXSV	Horizontal and Vertical Control Point
	VCP	V-CTRL-PNTS-VSCP-EXSV	Vertical Control Point

1.14.4 FEATURE SET: ENVIRONMENTAL



SYMBOL	BLOCK NAME	LAYER NAME	DESCRIPTION
	BH	V-ENVR-BORE-____-EXSV	Bore Hole
	EXW	V-ENVR-EXTW-____-EXSV	Extraction Well
	HDP	V-ENVR-HYDP-____-EXSV	Hydropunch
	LCB	V-ENVR-LEAB-____-EXSV	Leaching Basin
	MW	V-ENVR-MONW-____-EXSV	Monitoring Well

	SPT	V-ENVR-SETP-____-EXSV	Settling Point
	TP	V-ENVR-BORE-____-EXSV	Test Pit
	WFL	V-ENVR-WETL-____-EXSV	Wetland Flag







1.14.5 FEATURE SET: GENERAL

SYMBOL	BLOCK NAME	LAYER NAME	DESCRIPTION
	N_ARROW	V-GNRL-NOTE-SYMB-EXSV	North Arrow and Bar Scale
	NODE	(varies)	Node
	NO_END	(varies)	No End
	POINT	(varies)	Point
	REVISION	V-GNRL-NOTE-____-EXSV	Revision

1.14.6 FEATURE SET: HYSOGRAPHY



SYMBOL	BLOCK NAME	LAYER NAME	DESCRIPTION
	DTM	V-HYPS-DTMP-____-EXSV	Digital Terrain Model
	SSHT	V-HYPS-SPOT-____-EXSV	Spot Shot

1.14.7 FEATURE SET: PAVEMENT MARKINGS

SYMBOL	BLOCK NAME	LAYER NAME	DESCRIPTION
	HANDI	V-MARK-HNDI-____-EXSV	Handicap Symbol Park
	TD-6009L	V-MARK-ARWS-____-EXSV	90D Left Park
	TD-6009R	V-MARK-ARWS-____-EXSV	90D Right Park
	TD-6010L	V-MARK-ARWS-____-EXSV	Two Arrows Left Park
	TD-6010R	V-MARK-ARWS-____-EXSV	Two Arrows Right Park
	TD-6011L	V-MARK-ARWS-____-EXSV	30D Arrow Left Parking
	TD-6011R	V-MARK-ARWS-____-EXSV	30D Arrow Right Parking

	TD-6012	V-MARK-ARWS-____-EXSV	Arrows Straight and Right Park
	TD-6013	V-MARK-ARWS-____-EXSV	Single Arrow Parking
	TD-6014	V-MARK-ARWS-____-EXSV	Divided Arrows Parking
	TD-6015	V-MARK-ARWS-____-EXSV	Text on Parking "STOP"
	TD-6016	V-MARK-ARWS-____-EXSV	Text on Parking "ONLY"
	TD-6017	V-MARK-ARWS-____-EXSV	Arrows Straight and Left Park

1.14.8 FEATURE SET: PAVEMENT, ROAD, AND PARKING

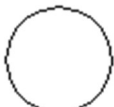
SYMBOL	BLOCK NAME	LAYER NAME	DESCRIPTION
	CBUMP	V-PAVE-CBAR-____-EXSV	Concrete Bumper
	DEL	V-PAVE-DLIN-SYMB-EXSV	DeLineator
	HR	V-PAVE-HAND-SYMB-EXSV	Handicap Ramp
	REF	V-PAVE-REFL-SYMB-EXSV	Reflector

1.14.9 FEATURE SET: RAILROAD

SYMBOL	BLOCK NAME	LAYER NAME	DESCRIPTION
	BXTR	V-RLRD-ELEC-____-EXSV	Trip Box
	POF	V-RLRD-PTOF-____-EXSV	Point of Frog
	POS	V-RLRD-PTOS-____-EXSV	Point of Switch
	RAS	V-RLRD-MISC-____-EXSV	Automatic Signal
	RBB	V-RLRD-MISC-____-EXSV	Bumping Block
	RCG	V-RLRD-MISC-____-EXSV	Crossing Gate
	RCT	V-RLRD-MISC-____-EXSV	Control Tower
	REI	V-RLRD-MISC-____-EXSV	EMP Pickup Indicator
	REP	V-RLRD-MISC-____-EXSV	REM Pickup Plat
	RIMP	V-RLRD-MISC-____-EXSV	Impedance Bond
	RIS	V-RLRD-MISC-____-EXSV	Interlocking Signal

	RPS	V-RLRD-MISC-____-EXSV	Stop Power Rail
	RQR	V-RLRD-MISC-____-EXSV	Route Request
	RSB	V-RLRD-MISC-____-EXSV	Smashboard
	RTI	V-RLRD-MISC-____-EXSV	Track Indicator
	SB	V-RLRD-MISC-____-EXSV	Switch Box

1.14.10 FEATURE SET: SIGN







SYMBOL	BLOCK NAME	LAYER NAME	DESCRIPTION
	RWSN	V-SIGN-RUNW-SYMB-EXSV	Sign Runway
	SN	V-SIGN-GNRL-SYMB-EXSV	Sign General
	SNP	V-SIGN-GNRL-____-EXSV	Sign Post
	VMS	V-SIGN-VMSS-SYMB-EXSV	Sign VMS

1.14.11 FEATURE SET: SITE FEATURES

SYMBOL	BLOCK NAME	LAYER NAME	DESCRIPTION
	ANT	V-SITE-MISC-PERM-EXSV	Antenna
	BNCH	V-SITE-MISC-PERM-EXSV	Park Bench
	BOL	V-SITE-MISC-PERM-EXSV	Bollard
	BRLS	V-SITE-BARL-SYMB-EXSV	Sand-Filled
	BUC	V-SITE-VEGE-TREE-EXSV	Coniferous Bush
	BUD	V-SITE-VEGE-TREE-EXSV	Deciduous Bush
	BUOY	V-SITE-MISC-PERM-EXSV	Buoy
	BUU	V-SITE-VEGE-TREE-EXSV	Unknown Bush
	BXS	V-SITE-MISC-PERM-EXSV	Steel Box
	BXSC	V-SITE-MISC-PERM-EXSV	Box w/ Steel Cover
	CLT	V-SITE-MISC-PERM-EXSV	Cleat

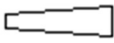

	DOL	V-SITE-MISC-PERM-EXSV	Dolphin
	FEND	V-SITE-MISC-TEMP-EXSV	Fender
	FP	V-SITE-FENC-POST-EXSV	Fence Post
	GDP	V-SITE-FENC-MISC-EXSV	Guard Post
	GP	V-SITE-FENC-POST-EXSV	Gate Post
	HDR	V-SITE-FENC-HDRL-EXSV	Handrail
	MB	V-SITE-MISC-PERM-EXSV	Mailbox
	MARSH	V-SITE-MRSH-____-EXSV	Marsh or Swamp
	MIP	V-SITE-MISC-PERM-EXSV	Mile Post
	PILE	V-SITE-MISC-PERM-EXSV	Pile
	PKGT	V-SITE-MISC-PERM-EXSV	Parking Gate

	PM	V-SITE-MISC-PERM-EXSV	Parking Meter
	POPIT	V-SITE-____-____-EXSV	Pump Out Pit
	POST	V-SITE-MISC-PERM-EXSV	Post
	PREG	V-SITE-____-____-EXSV	Pressure Regulator
	PTR	V-SITE-MISC-PERM-EXSV	Planter Round
	PTS	V-SITE-MISC-PERM-EXSV	Planter Square
	SD	V-SITE-MISC-PERM-EXSV	Satellite Dish
	STAT	V-SITE-MISC-PERM-EXSV	Statue or Monument
	STMP	V-SITE-VEGE-TREE-EXSV	Stump
	TDN	V-SITE-MISC-PERM-EXSV	Tie Down
	TICDIS	V-SITE-____-____-EXSV	Ticket Dispenser

	TRC	V-SITE-VEGE-TREE-EXSV	Coniferous Tree
	TRD	V-SITE-VEGE-TREE-EXSV	Deciduous Tree
	TWR	V-SITE-MISC-PERM-EXSV	Tower
	VENT	V-SITE-MISC-PERM-EXSV	Vent
	WF	V-SITE-MISC-PERM-EXSV	Water Fountain
	WS	V-SITE-MISC-PERM-EXSV	Windsock
	XFP	V-SITE-MISC-PERM-SYMB-EXSV	Flagpole

1.14.12 FEATURE SET: UTILITIES

1.14.12.1 Misc UTILITY CODES

SYMBOL	BLOCK NAME	LAYER NAME	DESCRIPTION
	END_CAP	V-UTIL-____-____-EXSV	End cap
	END_PLUG	V-UTIL-____-____-EXSV	End plug
	GW	V-UTIL-____-____-EXSV	Guy wire post

	GW2	V-UTIL-___-___-EXSV	Guy Wire w/ 2 Posts
	MTR	V-UTIL-___-___-EXSV	Meter
	OWS	V-UTIL-___-___-EXSV	Oil water separator
	PGOING	V-UTIL-___-___-EXSV	Ongoing pipe progression indicator
	PMPSTA	V-UTIL-___-___-EXSV	Pump station
	REDUC	V-UTIL-___-___-EXSV	Reducer
	TEE	V-UTIL-___-___-EXSV	Tee
	TH	V-UTIL-___-___-EXSV	Test Hole
	TMKR	V-UTIL-___-___-EXSV	Temporary marker

	WPO	V-UTIL-____-____-EXSV	Wood Utility Pole
	WYE	V-UTIL-____-____-EXSV	Wye

1.14.12.2 AIR UTILITY CODES

SYMBOL	BLOCK NAME	LAYER NAME	DESCRIPTION
	MHA	V-UTIL-AIRL-____-EXSV	Air Manhole
	UGMA	V-UTIL-AIRL-MARK-EXSV	Under Ground Air Pipe Marker

1.14.12.3 CHILLED WATER

SYMBOL	BLOCK NAME	LAYER NAME	DESCRIPTION
	CWV	V-UTIL-CHIL-____-EXSV	Chilled Water Valve
	FCC	V-UTIL-CHIL-____-EXSV	Filled Cap Chilled Water

1.14.12.4 COMBINED UTILITY CODES

SYMBOL	BLOCK NAME	LAYER NAME	DESCRIPTION
	CB	V-UTIL-COMB-____-EXSV	Single CB Combined
	CBD	V-UTIL-COMB-____-EXSV	Double CB Combined

	CBR	V-UTIL-COMB-____-EXSV	Round CB Combined
	CBS	V-UTIL-COMB-____-EXSV	Square CB Combined
	CO	V-UTIL-COMB-____-EXSV	Cleanout Combined
	MHSS	V-UTIL-COMB-____-EXSV	Combined Manhole

1.14.12.5 Misc. COMMUNICATION UTILITY CODES

SYMBOL	BLOCK NAME	LAYER NAME	DESCRIPTION
	BXC	V-UTIL-COMM-____-EXSV	Communication Box
	CR	V-UTIL-COMM-____-EXSV	Card Reader
	CRSR	V-UTIL-COMM-____-EXSV	Communication Riser
	HHC	V-UTIL-COMM-____-EXSV	Handhole Communication
	MHC	V-UTIL-COMM-____-EXSV	General Communication MH
	UGMC	V-UTIL-COMM-MARK-EXSV	Under Ground Communications Pipe Marker

1.14.12.6 FAA UTILITY CODES

SYMBOL	BLOCK NAME	LAYER NAME	DESCRIPTION
	MHFAA	V-UTIL-CFAA-____-EXSV	Communication FAA MH
	FAALOC	V-UTIL-CFAA-____-EXSV	FAA Localizer

1.14.12.7 FIRE UTILITY CODES

SYMBOL	BLOCK NAME	LAYER NAME	DESCRIPTION
	BXF	V-UTIL-CFIR-____-EXSV	Fire Pull Box
	MHFI	V-UTIL-CFIR-____-EXSV	Communication Fire MH
	WPF	V-UTIL-CMFI-____-EXSV	Wood Pole w/ Fire Box
	UGMFI	V-UTIL-CFIR-MARK-EXSV	Under Ground Fire Pipe Marker

1.14.12.8 SECURITY UTILITY

SYMBOL	BLOCK NAME	LAYER NAME	DESCRIPTION
	MHSC	V-UTIL-CSEC-____-EXSV	Communication MH Security

1.14.12.9 TELEPHONE UTILITY

SYMBOL	BLOCK NAME	LAYER NAME	DESCRIPTION
	BXT	V-UTIL-CTEL-____-EXSV	Telephone Box

	MHT	V-UTIL-CTEL-____-EXSV	Telephone MH
	PB	V-UTIL-CTEL-____-EXSV	Phone Booth
	PP	V-UTIL-CTEL-____-EXSV	Phone Post
	UGMTE	V-UTIL-CTEL-MARK-EXSV	Under Ground Telephone Pipe Marker

1.14.12.10 TRAFFIC UTILITY

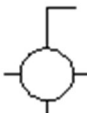
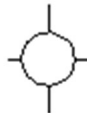

SYMBOL	BLOCK NAME	LAYER NAME	DESCRIPTION
	BXTC	V-UTIL-CTRF-____-EXSV	Traffic Signal Box
	MHTC	V-UTIL-CTRF-____-EXSV	Communication MH Traffic
	MTL	V-UTIL-CTRF-____-EXSV	Metal Traffic Signal
	MTLCAM	V-UTIL-CTRF____-EXSV	Metal Traffic Signal w/ Camera
	SPLBX	V-UTIL-CTRF-____-EXSV	Splice Box
	TRFS	V-UTIL-CTRF-____-EXSV	Traffic Sensor

	UGMTR	V-UTIL-CTRF-MARK-EXSV	Under Ground Traffic Pipe Marker
	WPT	V-UTIL-CTRF-____-EXSV	Wood Pole w/ Traffic Signal
	WTL	V-UTIL-CTRF-____-EXSV	Traffic Signal Pole

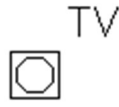
1.14.12.11 TELEVISION UTILITY

SYMBOL	BLOCK NAME	LAYER NAME	DESCRIPTION
	MHTV	V-UTIL-CMTV-____-EXSV	Communication MH Cable TV
	UGMTV	V-UTIL-CMTV-MARK-EXSV	Under Ground Cable TV Pipe Marker

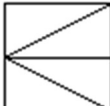
1.14.12.12 DRAINAGE UTILITY

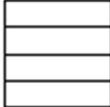
SYMBOL	BLOCK NAME	LAYER NAME	DESCRIPTION
	CB	V-UTIL-DRAN-____-EXSV	Single Catch Basin
	CBD	V-UTIL-DRAN-____-EXSV	Double Catch Basin
	CBR	V-UTIL-DRAN-____-EXSV	Round Catch Basin
	CBS	V-UTIL-DRAN-____-EXSV	Square Catch Basin







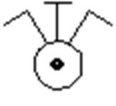
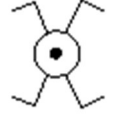

	DISUMP	V-UTIL-DRAN-____-EXSV	De-icing Sump
	DIV	V-UTIL-DRAN-____-EXSV	De-icing Storm Valve
	DMTR	V-UTIL-DRAN-____-EXSV	Mitered End
	DRN	V-UTIL-DRAN-____-EXSV	Drain or Scupper
	DRS	V-UTIL-DRAN-____-EXSV	Drainage Sump
	DV	V-UTIL-DRAN-____-EXSV	Drainage Valve
	HEADWL	V-UTIL-DRAN-____-EXSV	Headwall
	MHD	V-UTIL-DRAN-____-EXSV	Storm Drainage MH
	MHGD	V-UTIL-DRAN-____-EXSV	Storm Drainage MH with Square or Rectangle Base
	OR	V-UTIL-DRAN-____-EXSV	Observation Riser
	OUTFALL	V-UTIL-DRAN-____-EXSV	Outfall

	PMPSTAD	V-UTIL-DRAN-____-EXSV	Pump Station Drainage
	SUMP	V-UTIL-DRAN-____-EXSV	Storm Drain Sump
	UGMD	V-UTIL-DRAN-____-EXSV	Under Ground Pipe Marker Storm Drainage

1.14.12.13 ELECTRIC UTILITY

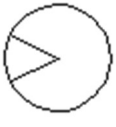
SYMBOL	BLOCK NAME	LAYER NAME	DESCRIPTION
	APLT	V-UTIL-ELEC-____-EXSV	Approach Light
	BRKRHS	V-UTIL-ELEC-____-EXSV	Breaker Housing
	BXE	V-UTIL-ELEC-____-EXSV	Electric Box
	BXER	V-UTIL-ELEC-____-EXSV	Recessed Electric Box
	BXP	V-UTIL-ELEC-____-EXSV	Electric Pull Box
	EGATE	V-UTIL-ELEC-____-EXSV	Electrical Gate

	EM	V-UTIL-ELEC-____-EXSV	Electric Meter
	EMP	V-UTIL-ELEC-____-EXSV	Electric Meter Pit
	ERSR	V-UTIL-ELEC-____-EXSV	Electrical Riser
	GEN	V-UTIL-ELEC-____-EXSV	Generator
	HHE	V-UTIL-ELEC-____-EXSV	Handhole Electrical
	LP	V-UTIL-ELEC-____-EXSV	Private Lamp Post
	LT	V-UTIL-ELEC-____-EXSV	Light
	LTWR	V-UTIL-ELEC-____-EXSV	Low Press Water Line
	MHE	V-UTIL-ELEC-____-EXSV	Electric MH
	MLP	V-UTIL-ELEC-____-EXSV	Metal Single Street Light Tower
	MP10L	V-UTIL-ELEC-____-EXSV	Metal 10 Light Tower

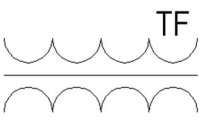
	MP2L	V-UTIL-ELEC-____-EXSV	Metal Double Light Tower
	MP3L	V-UTIL-ELEC-____-EXSV	Metal Triple Light Tower
	MP4L	V-UTIL-ELEC-____-EXSV	Metal Four Light Tower
	MPED	V-UTIL-ELEC-____-EXSV	Metal w/ PED Light
	RWCLT	V-UTIL-ELEC-____-EXSV	Runway CL Light
	RWELT	V-UTIL-ELEC-____-EXSV	Runway Edge Light
	RWHLT	V-UTIL-ELEC-____-EXSV	Runway Hold Light
	RWLT	V-UTIL-ELEC-____-EXSV	Runway Light
	SSCC	V-UTIL-ELEC-____-EXSV	Surveillance Sys Control Cabinet
	STG	V-UTIL-ELEC-____-EXSV	Substa. Trnsfrmr Switch Gear
	TF	V-UTIL-ELEC-____-EXSV	Transformer

	THLT	V-UTIL-ELEC-____-EXSV	Taxiway Hold Light
	TRMT_WLD	V-UTIL-ELEC-____-EXSV	Thermite Weld Wire Attachment
	TSCC	V-UTIL-ELEC-____-EXSV	Traffic Sign Control Cabinet
	TWCLT	V-UTIL-ELEC-____-EXSV	Taxiway CL Light
	TWELT	V-UTIL-ELEC-____-EXSV	Taxiway Edge Light
	TWLT	V-UTIL-ELEC-____-EXSV	Taxiway Light
	TWSN	V-UTIL-ELEC-____-EXSV	Taxiway Sign
	TWSN2X	V-UTIL-ELEC-____-EXSV	Taxiway Sign Double Sided
	UGME	V-UTIL-ELEC-MARK-EXSV	Under Ground Electrical Pipe Marker
	VASI	V-UTIL-ELEC-____-EXSV	Vasi Light
	VMCC	V-UTIL-ELEC-____-EXSV	Variable Message Control Cabinet

	WLP	V-UTIL-ELEC-____-EXSV	Wood Pole w/ Street Light
	WP2L	V-UTIL-ELEC-____-EXSV	Wood Pole w/ 2 Lights

1.14.12.14 CATHODIC PROTECTION UTILITY

SYMBOL	BLOCK NAME	LAYER NAME	DESCRIPTION
	CPPDAG	V-UTIL-ELCP-____-EXSV	Cath Pro Deep Anode Grounded
	CPPREH	V-UTIL-ELCP-____-EXSV	Cath Pro Perm Ref Electrode Horz
	CPPREV	V-UTIL-ELCP-____-EXSV	Cath Pro Perm Ref Electrode Vert
	CPTS-FM	V-UTIL-ELCP-____-EXSV	Cath Pro Test Sta Flush-Mounted
	CPTS-WM	V-UTIL-ELCP-____-EXSV	Cath Pro Test Sta Wall-Mounted
	NEGRETJB	V-UTIL-ELCP-____-EXSV	Cath Pro Negative Junction Box
	POSRETJB	V-UTIL-ELCP-____-EXSV	Cath Pro Positive Junction Box
	RECTIFIER	V-UTIL-ELCP-____-EXSV	Cath Pro Rectifier

	RMU	V-UTIL-ELCP-____-EXSV	Cath Pro Remote Monitoring Unit
--	-----	-----------------------	---------------------------------

1.14.12.15 FOAM UTILITY

SYMBOL	BLOCK NAME	LAYER NAME	DESCRIPTION
	FMCB	V-UTIL-FOAM-____-EXSV	Foam Cabinet
	FMHSE	V-UTIL-FOAM-____-EXSV	Foam Housing
	FMNOZ	V-UTIL-FOAM-____-EXSV	Foam Nozzle
	FMVALV	V-UTIL-FOAM-____-EXSV	Foam Valve
	HPWTIE	V-UTIL-FOAM-____-EXSV	Tie to High Press Water
	MHFM	V-UTIL-FOAM-____-EXSV	Foam MH
	UGMFO	V-UTIL-FOAM-MARK-EXSV	Under Ground Foam Pipe Marker

1.14.12.16 FUEL UTILITY

SYMBOL	BLOCK NAME	LAYER NAME	DESCRIPTION
	BLKFLANG	V-UTIL-FUEL-____-EXSV	Blank Flang
	BRKOUT	V-UTIL-FUEL-____-EXSV	Break Between PA and Non-PA
	FCD	V-UTIL-FUEL-____-EXSV	Filler Cap Diesel
	FCF	V-UTIL-FUEL-____-EXSV	Filler Cap Fuel
	FCG	V-UTIL-FUEL-____-EXSV	Filler Cap Gas
	FCJ	V-UTIL-FUEL-____-EXSV	Filler Cap JetA
	FCO	V-UTIL-FUEL-____-EXSV	Filler Cap Oil
	FCP	V-UTIL-FUEL-____-EXSV	Filler Cap Propane
	FILTSTA	V-UTIL-FUEL-____-EXSV	Fuel Filtration Station
	FIW	V-UTIL-FUEL-____-EXSV	Fuel Inspection Well

	FUI	V-UTIL-FUEL-___-EXSV	Fuel Isolation
	FUP	V-UTIL-FUEL-___-EXSV	Fuel Pump
	FUELPOST	V-UTIL-FUEL-___-EXSV	Fuel Listening Post
	FUELTANK	V-UTIL-FUEL-___-EXSV	Fuel Tank
	FUVT	V-UTIL-FUEL-___-EXSV	Fuel Vent
	FV	V-UTIL-FUEL-___-EXSV	Fuel Valve
	FVP	V-UTIL-FUEL-___-EXSV	Fuel Valvepit
	GLV	V-UTIL-FLGS-___-EXSV	Gasoline Valve
	HYDPIT	V-UTIL-FUEL-___-EXSV	Fuel Hydrant Pit
	LRAKBOT	V-UTIL-FUEL-___-EXSV	Loading Rack Bottom

	LRAKTOP	V-UTIL-FUEL-____-EXSV	Loading Rack Top
	MHFL	V-UTIL-FUEL-____-EXSV	Fuel MH
	PIG	V-UTIL-FUEL-____-EXSV	PIG Access
	PMPSTAF	V-UTIL-FUEL-____-EXSV	Pump Station Fuel
	TESTSTA	V-UTIL-FUEL-____-EXSV	Test Station Fuel
	UGMFL	V-UTIL-FUEL-MARK-EXSV	Under Ground Fuel Pipe Marker
	VNTP	V-UTIL-FUEL-____-EXSV	Vent Pit

1.14.12.17 NATURAL GAS

SYMBOL	BLOCK NAME	LAYER NAME	DESCRIPTION
	BXG	V-UTIL-NGAS-____-EXSV	Natural Gas Box
	CMST	V-UTIL-NGAS-____-EXSV	Compressor Station
	GM	V-UTIL-NGAS-____-EXSV	Natural Gas Meter

	GRSR	V-UTIL-NGAS-____-EXSV	Natural Gas Riser
	GT	V-UTIL-NGAS-____-EXSV	Natural Gas Test
	GV	V-UTIL-NGAS-____-EXSV	Natural Gas Valve
	MHG	V-UTIL-NGAS-____-EXSV	Natural Gas MH
	UGMG	V-UTIL-NGAS-MARK-EXSV	Under Ground Natural Gas Pipe Marker

1.14.12.18 SANITARY UTILITY

SYMBOL	BLOCK NAME	LAYER NAME	DESCRIPTION
	MHS	V-UTIL-SSWR-____-EXSV	Sanitary Sewer MH Grav.
	PMPSTAS	V-UTIL-SSWR-____-EXSV	Pump Station Sanitary
	STANK	V-UTIL-SSWR-____-EXSV	Sludge Tank
	SV	V-UTIL-SSWR-____-EXSV	Sanitary Valve Grav

1.14.12.19 STEAM UTILITY

SYMBOL	BLOCK NAME	LAYER NAME	DESCRIPTION
	MHST	V-UTIL-STEM-____-EXSV	Steam MH
	MHSTB	V-UTIL-STEM-____-EXTN	Steam MH Buried
	STEAMA	V-UTIL-STEM-____-EXSV	Steam Anchor Block
	STEAMCC	V-UTIL-STEM-____-EXSV	Steam Cooling Chamber
	STEAMEJ	V-UTIL-STEM-____-EXSV	Steam Expansion Joint
	STEAMMG	V-UTIL-STEM-____-EXSV	Steam Moon Guide
	STEAMSJ	V-UTIL-STEM-____-EXSV	Steam Slip Joint
	STEAMV	V-UTIL-STEM-____-EXSV	Steam Valve
	UGMST	V-UTIL-STEM-MARK-EXSV	Under Ground Steam Pipe Marker

1.14.12.20 TDS UTILITY

SYMBOL	BLOCK NAME	LAYER NAME	DESCRIPTION
	BXTDS	V-UTIL-TDSL-____-EXSV	Thermal Distribution System Box
	MHTW	V-UTIL-TDSL-____-EXSV	TDS Water MH
	TDSV	V-UTIL-TDSL-____-EXSV	TDS Valve w/ Structure
	TDSVA	V-UTIL-TDSL-____-EXSV	TDS Valve w/ Activator
	TDSVNS	V-UTIL-TDSL-____-EXSV	TDS Valve w/o Structure
	UGMTD	V-UTIL-TDSL-MARK-EXSV	Under Ground TDS Pipe Marker
	VPTM	V-UTIL-TDSL-____-EXSV	TDS Valve Pit Manhole

1.14.12.21 UNKNOWN UTILITY





SYMBOL	BLOCK NAME	LAYER NAME	DESCRIPTION
	BXU	V-UTIL-UKWN-____-EXSV	Unknown Box
	CROSS	V-UTIL-UKWN-____-EXSV	Four Way Tee

	FCU	V-UTIL-UKWN-____-EXSV	Filler Cap Unknown
	HH	V-UTIL-UKWN-____-EXSV	Handhole
	MH	V-UTIL-UKWN-____-EXSV	Manhole
	MHPS	V-UTIL-UKWN-____-EXSV	Manhole Public Service
	TEE	V-UTIL-UKWN-____-EXSV	Tee Unknown
	UV	V-UTIL-UKWN-____-EXSV	Unknown Valve

1.14.12.22 WATER UTILITY

SYMBOL	BLOCK NAME	LAYER NAME	DESCRIPTION
	BXH2O	V-UTIL-WATR-____-EXSV	Portable Water Box
	BXSP	V-UTIL-WAIR-____-EXSV	Sprinkler Control Box
	BXW	V-UTIL-WATR-____-EXSV	Water Box
	HOTBOX	V-UTIL-WATR-____-EXSV	Water Meter Box

	HPTIE	V-UTIL-WAIR-____-EXSV	Irrig. Tie to High Press Water
	HYD	V-UTIL-WATR-____-EXSV	Hydrant
LP 	HYDL	V-UTIL-WALP-____-EXSV	Low Press Hydrant
MP 	HYDM	V-UTIL-WAMP-____-EXSV	Med Press Hydrant
MP 	HYDH	V-UTIL-WAHP-____-EXSV	High Press Hydrant
	IRCP	V-UTIL-WAIR-____-EXSV	Irrigation Control Panel
IR 	IRV	V-UTIL-WAIR-____-EXSV	Irrigation Valve
	MHW	V-UTIL-WATR-____-EXSV	Water MH
	PIV	V-UTIL-WATR-____-EXSV	Post Indicator Valve
SPH 	SPH	V-UTIL-WAIR-____-EXSV	Sprinkler Head

	SPIGOT	V-UTIL-WATR-____-EXSV	Spigot
	STP	V-UTIL-WATR-____-EXSV	Stand Pipe
	TANK	V-UTIL-WATR-____-EXSV	Water Tank
	WRSR	V-UTIL-WATR-____-EXSV	Water Riser
	WV	V-UTIL-WATR-____-EXSV	Water Valve

1.16 APPENDIX F – CONTRACT BORDERS

1.16.1 CONTRACT BORDER

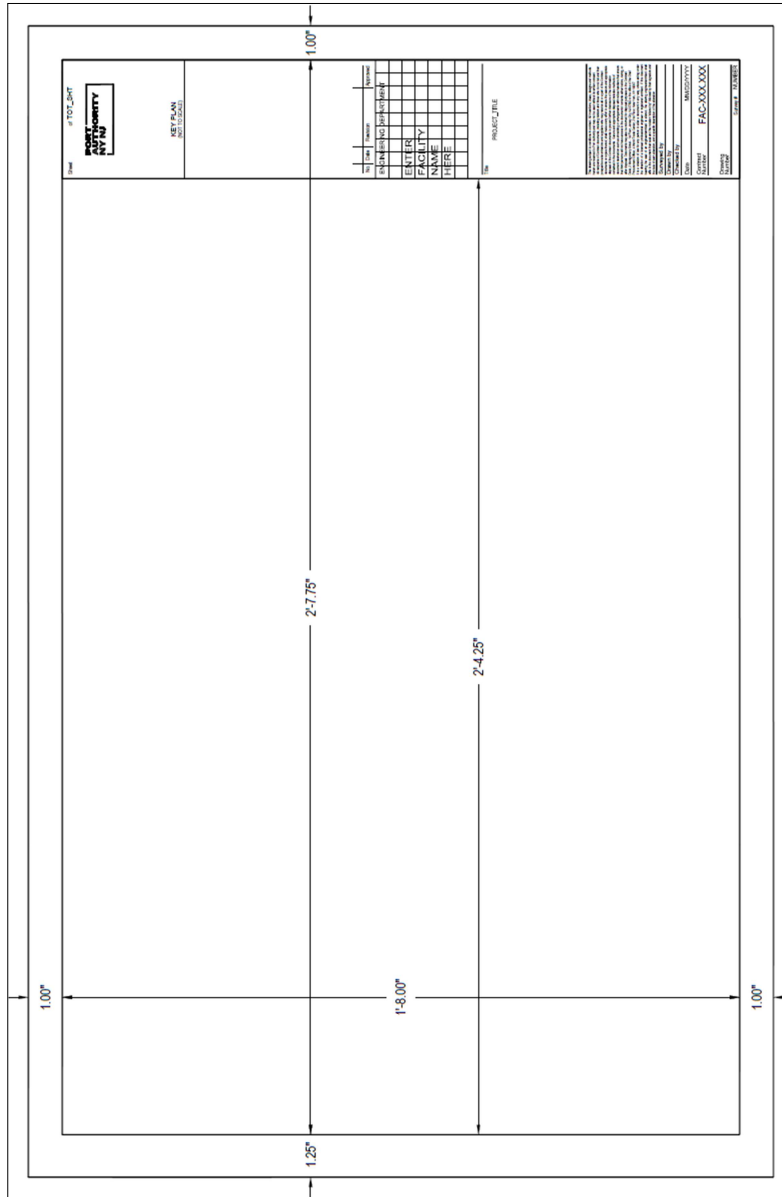

1.16.2 CONTRACT BORDER – OS

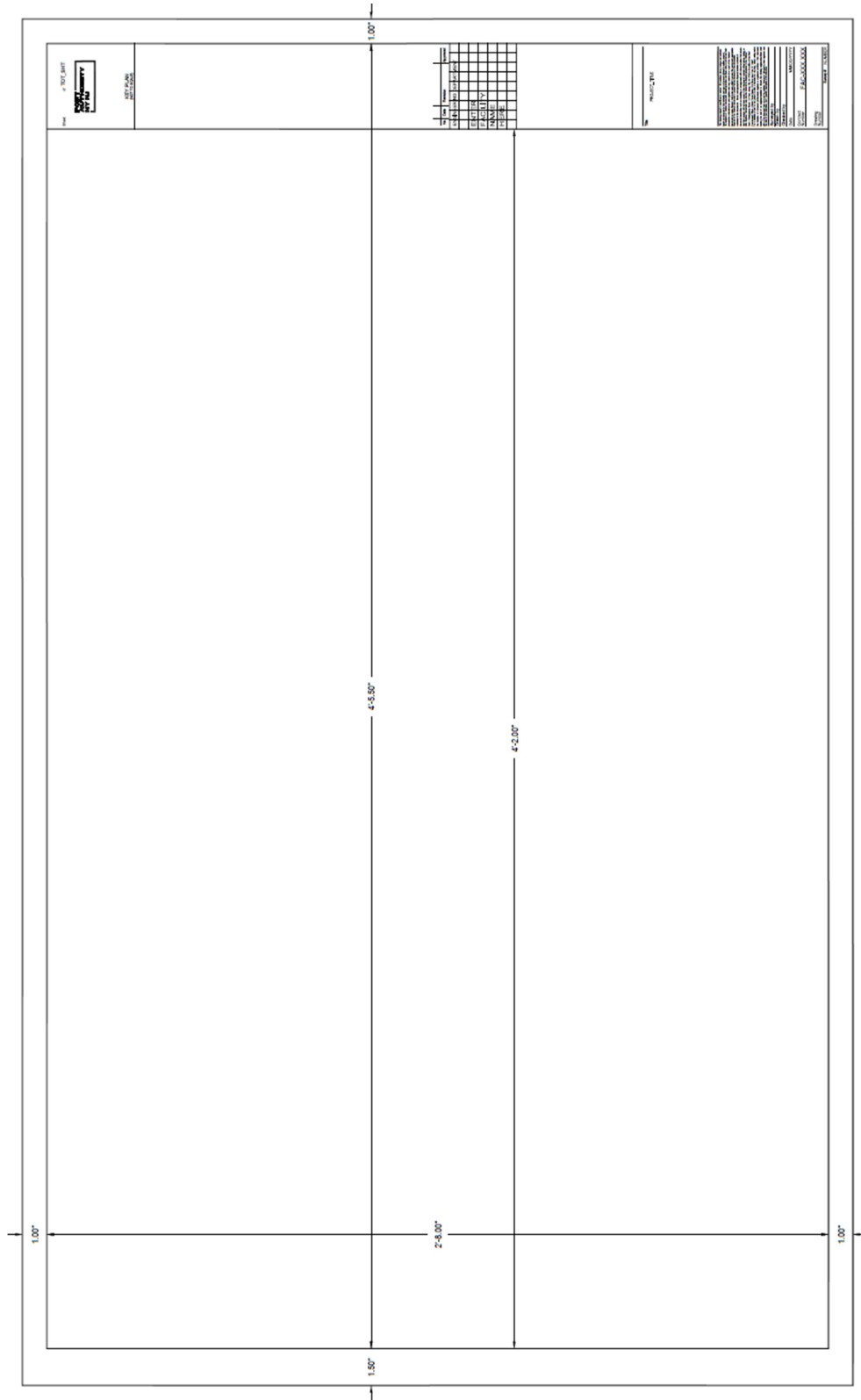

1.17 APPENDIX G - CIVIL 3D

1.17.1 DATA SHORTCUTS (CIVIL 3D OBJECT SHARING)

Most AutoCAD users are familiar with referencing techniques for sharing drawing information, such as XREF, wblock, import and attach. Civil 3D uses intelligent objects, such as surfaces and profiles, which do not retain intelligence through typical external references*. The proper way to share intelligent Civil 3D objects is through Data Shortcuts. Objects include:

- Alignments
- Surfaces
- Profiles
- Sections
- Corridors
- Pipe Networks
- Pressure Pipe Networks

Note: *Users can add labels to civil objects through external referencing, but cannot design/build or modify the display of data, with the exception of controlling display through the use of layers.

The Data Shortcut method involves two steps, Sharing (export) and Referencing (import).

1.17.2 SHARING DATA SHORTCUTS

Open the drawing containing the civil objects to be shared.

1.17.2.1 SET THE WORKING FOLDER

Right click on the Data Shortcut and select Set Working folder. Each project will have its own Working folder. This folder will be set to the Project Data folder within its respective CSG Project Folder.

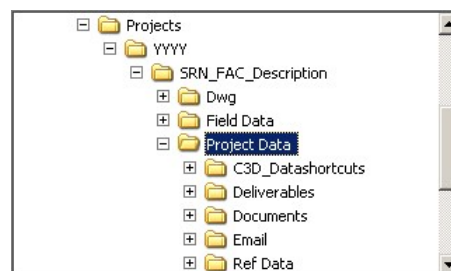

1.17.2.2 CREATE A NEW DATA SHORTCUTS FOLDER

Right click the Data Shortcuts again and select **New Data Shortcuts Project Folder...**

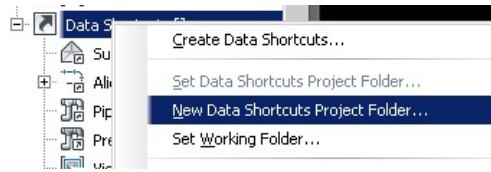

Enter the name **C3D_Datashortcuts** and click **OK**. (Do Not Check box for 'Use Project Template')

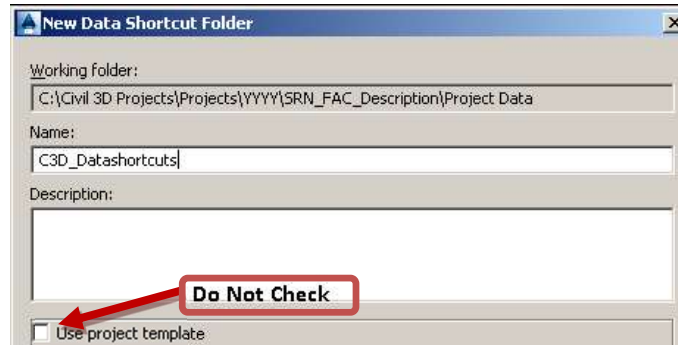

1.17.2.3 CREATING DATA SHORTCUTS

Right Click Data Shortcuts and select **Create Data Shortcuts...**



Civil 3D will collect all applicable intelligent civil objects within the drawing and display them in a dialog box. Users can specify which objects they wish to share by checking them on/off. Multiple objects, such as surfaces and alignments, can be added to the data shortcut at the same time.

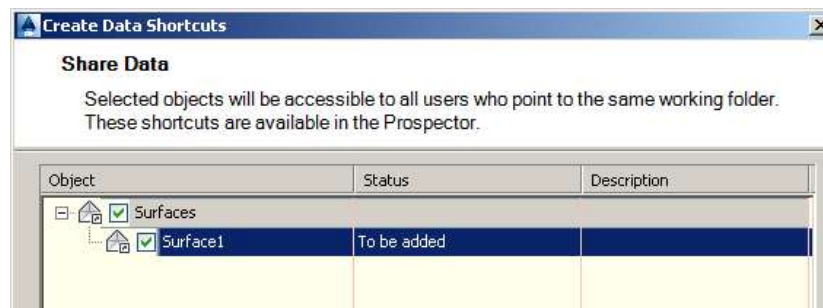

Check desired objects to share and select **OK**.

Note: The data shortcut is saved to the C3D_Datashortcuts folder in xml format. If the object is modified in the native drawing, the xml and drawings referencing the data shortcut will automatically update.

1.17.2.4 REFERENCING DATA SHORTCUTS

In order to Reference a data shortcut the working folder will need to be set to the appropriate location. Refer to **1.17.2.1 Set the Working Folder**.

The Data Shortcuts will display a + symbol next to the object types available for reference. Click the + to expand the object type. Highlight the object, right click and select **Create Reference...**

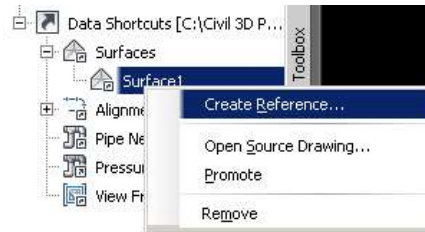

A dialog box will appear to allow the user to set or change the object style and name. Once these options have been set select **OK**.

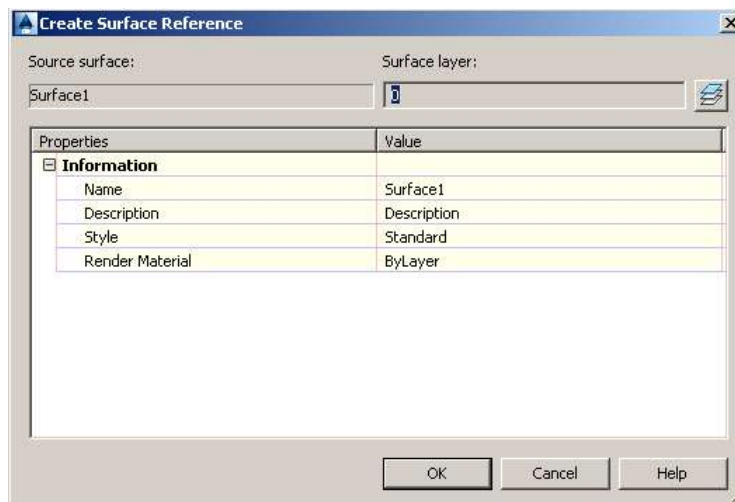

1.17.3 PIPE NETWORKS

The Port Authority of NY & NJ has compiled sets of custom parts for use with Civil 3D Pipe Networks. There are several part families for both Pipes and Structures. The Pipe Network Catalog Settings should be mapped to the designated location for all Civil 3D users to access both standard parts and Port Authority custom parts:

1.17.3.1 PIPE NETWORKS

Set the Pipe Network Catalog to:

[Eng Operations Project Controls - VDC Group - VDC Documents - All Documnets \(sharepoint.com\)](https://sharepoint.com)

The available Pipe catalogs are:

- Metric Pipe Catalog
- **Port Authority of NY and NJ Custom Pipe Catalog**

- US Imperial Pipe Catalog

The available Structure catalogs are:

- Metric Structure Catalog
- *Port Authority of NY and NJ Custom Structure Catalog*
- US Imperial Structure Catalog

After the catalogs have been set to the **Port Authority of NY and NJ Custom Catalogs** Pipe Network parts lists can be created and edited using custom Port Authority parts.

A complete list and description of pipes can be found at [Eng Operations Project Controls - VDC Group - VDC Documents - PA-Pipes.htm \(sharepoint.com\)](#)

A complete list and description of structures can be found at [Eng Operations Project Controls - VDC Group - VDC Documents - PA-Structures.htm \(sharepoint.com\)](#)

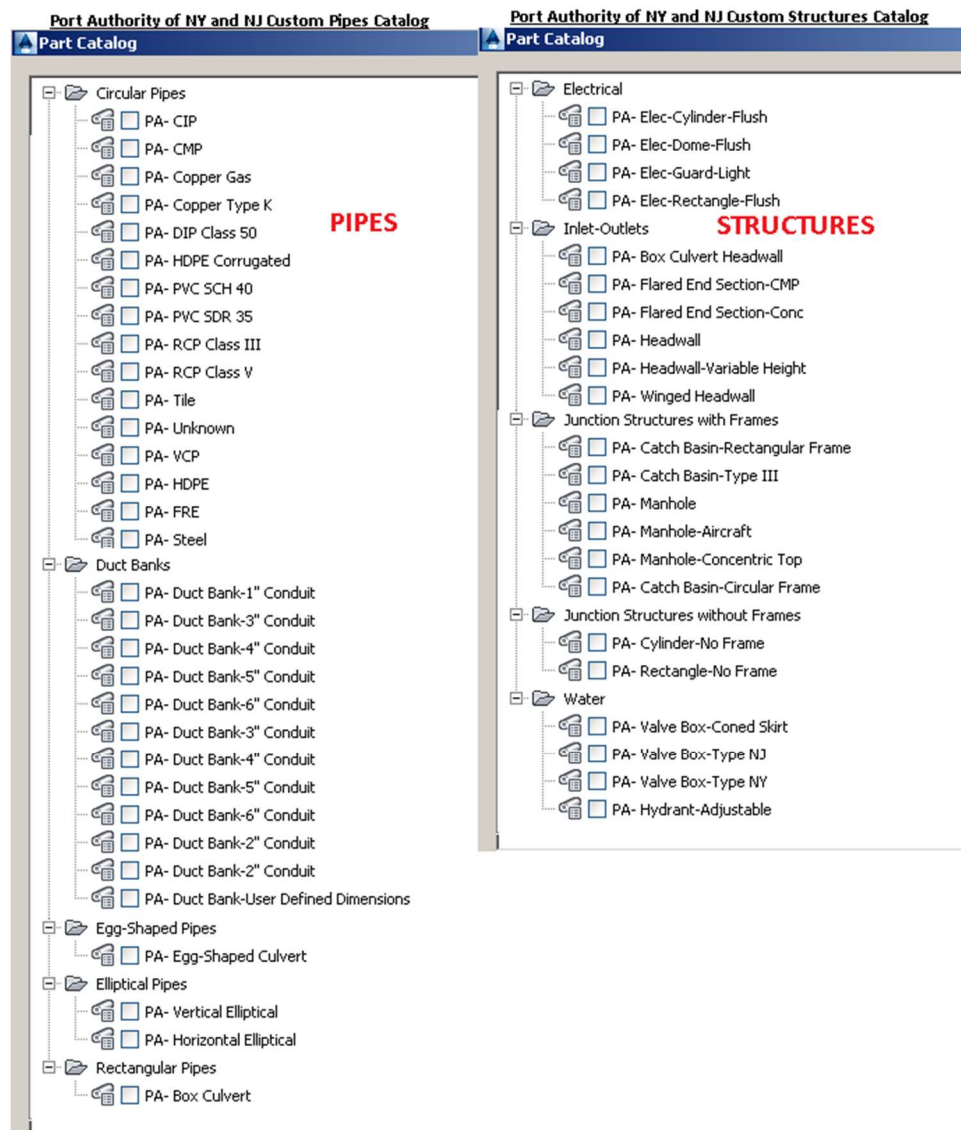

1.18 APPENDIX H - REQUEST TO CHANGE STANDARD



Engineering CAD/BIM Support Group

THE PORT AUTHORITY OF NY & NJ

E/A Design Division CAD Standards

DISCLAIMER

By making this submission you, the submitter, agrees that no contractual confidential relationship is established between you and the issuer of this Standard. If your material is incorporated into this Standard, you will not be compensated. In addition, if the material which you have submitted on this form is protected by any copyright, patent, trademark, or other proprietary right, then you are granting the issuer of this Standard a non-exclusive, royalty-free, perpetual and fully transferable license to use the materials in connection with this Standard.

SUBMITTER INFORMATION

Name, Date, Company, Address, Address, City, State, ZIP, Phone, Email

APPROVED BY

Architectural, Civil, Electrical, Environmental, Geotechnical, Mechanical, Structural, Traffic, CAD Support

CAD STANDARD INFORMATION

Version of Standard to Update

CHANGE INFORMATION

Section to be Changed

Change Type

Change Description

Large empty box for change description

APPROVAL / DENIAL INFORMATION

Large empty box for approval/denial information